

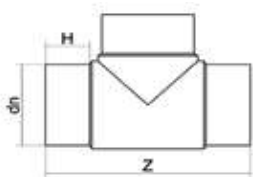

## Ti 90° codolo lungo

Fabbricato mediante stampaggio

### SDR17 PN10



### SDR11 PN16

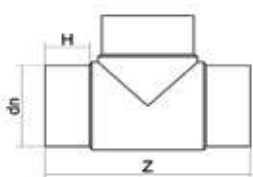

| dn  | codice | €       | Q Box | CP | Peso [kg] |
|-----|--------|---------|-------|----|-----------|
| 63  | TP063B | 11,40   | 38    | 12 | 0,30      |
| 75  | TP075B | 15,40   | 23    | 12 | 0,45      |
| 90  | TP090B | 24,40   | 14    | 12 | 0,83      |
| 110 | TP110B | 36,40   | 7     | 16 | 1,28      |
| 125 | TP125B | 55,10   | 5     | 16 | 1,66      |
| 140 | TP140B | 80,10   | 63    | 1  | 2,60      |
| 160 | TP160B | 101,50  | 48    | 1  | 3,30      |
| 180 | TP180B | 136,70  | 32    | 1  | 4,30      |
| 200 | TP200B | 173,90  | 29    | 1  | 5,50      |
| 225 | TP225B | 236,60  | 19    | 1  | 7,90      |
| 250 | TP250B | 347,70  | 14    | 1  | 11,50     |
| 280 | TP280B | 615,10  | 9     | 1  | 15,30     |
| 315 | TP315B | 629,70  | 7     | 1  | 20,40     |
| 355 | TP355B | 1002,90 | 6     | 1  | 30,40     |
| 400 | TP400B | 1537,60 | 4     | 1  | 42,80     |
| 450 | TP450B | 1938,70 | 2     | 1  | 60,80     |
| 500 | TP500B | 2741,00 | 2     | 1  | 78,70     |
| 560 | TP560B | 3382,80 | 1     | 1  | 109,60    |
| 630 | TP630B | 4706,40 | 1     | 1  | 147,40    |

| dn  | codice | €       | Q Box | CP | Peso [kg] |
|-----|--------|---------|-------|----|-----------|
| 20  | TP020C | 6,00    | -     | -  | 0,04      |
| 25  | TP025C | 6,00    | 50    | 60 | 0,05      |
| 32  | TP032C | 6,70    | 30    | 60 | 0,07      |
| 40  | TP040C | 7,90    | 44    | 32 | 0,12      |
| 50  | TP050C | 8,90    | 30    | 32 | 0,18      |
| 63  | TP063C | 11,90   | 44    | 12 | 0,31      |
| 75  | TP075C | 16,40   | 28    | 12 | 0,60      |
| 90  | TP090C | 26,00   | 16    | 12 | 1,11      |
| 110 | TP110C | 38,30   | 7     | 16 | 1,70      |
| 125 | TP125C | 58,20   | 5     | 16 | 2,30      |
| 140 | TP140C | 84,70   | 70    | 1  | 3,04      |
| 160 | TP160C | 107,40  | 48    | 1  | 4,50      |
| 180 | TP180C | 144,80  | 35    | 1  | 5,80      |
| 200 | TP200C | 186,00  | 29    | 1  | 7,70      |
| 225 | TP225C | 250,40  | 20    | 1  | 10,70     |
| 250 | TP250C | 373,20  | 14    | 1  | 14,60     |
| 280 | TP280C | 650,40  | 9     | 1  | 21,60     |
| 315 | TP315C | 667,40  | 7     | 1  | 28,00     |
| 355 | TP355C | 1249,60 | 6     | 1  | 40,30     |
| 400 | TP400C | 1790,50 | 4     | 1  | 56,40     |
| 450 | TP450C | 2331,30 | 2     | 1  | 81,20     |
| 500 | TP500C | 3246,60 | 2     | 1  | 108,00    |
| 560 | TP560C | 4251,80 | 1     | 1  | 149,00    |
| 630 | TP630C | 5733,50 | 1     | 1  | 200,00    |

Altre misure e/o SDR a richiesta  
 €...: Prezzo a richiesta



## Ti 90° codolo lungo

Fabbricato mediante stampaggio

### SDR9 PN20

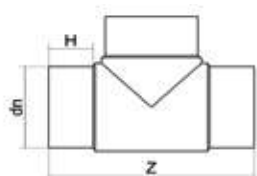

| dn  | codice | €         | Q Box | CP | Peso [kg] |
|-----|--------|-----------|-------|----|-----------|
| 63  | TP063G | 30,50     | 44    | 12 | 0,47      |
| 75  | TP075G | 36,80     | 28    | 12 | 0,74      |
| 90  | TP090G | 47,80     | 16    | 12 | 1,30      |
| 110 | TP110G | 70,90     | 7     | 16 | 2,00      |
| 125 | TP125G | 117,30    | 5     | 16 | 2,73      |
| 140 | TP140G | 165,30    | 70    | 1  | 3,79      |
| 160 | TP160G | 222,50    | 48    | 1  | 5,40      |
| 180 | TP180G | 379,30    | 2     | 12 | 7,02      |
| 200 | TP200G | 502,10    | 29    | 1  | 9,70      |
| 225 | TP225G | 618,80    | 20    | 1  | 13,00     |
| 250 | TP250G | 1017,30   | 14    | 1  | 17,30     |
| 280 | TP280G | 1417,30   | 9     | 1  | 25,00     |
| 315 | TP315G | 1701,70   | 7     | 1  | 34,00     |
| 355 | TP355G | 1871,90   | 6     | 1  | 46,60     |
| 400 | TP400G | 2601,30   | 4     | 1  | 64,40     |
| 450 | TP450G | 3690,30   | 2     | 1  | 94,60     |
| 500 | TP500G | 5263,10   | 2     | 1  | 126,80    |
| 560 | TP560G | 8.960,00  | 1     | 1  | 168,00    |
| 630 | TP630G | 10.500,00 | 1     | 1  | 228,00    |

### SDR7,4 PN25

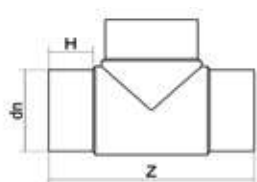

| dn  | codice | €        | Q Box | CP | Peso [kg] |
|-----|--------|----------|-------|----|-----------|
| 25  | TP025H | 12,40    | 50    | 60 | 0,06      |
| 32  | TP032H | 13,70    | 30    | 60 | 0,09      |
| 40  | TP040H | 14,90    | 44    | 32 | 0,17      |
| 50  | TP050H | 18,30    | 30    | 32 | 0,24      |
| 63  | TP063H | 23,50    | 44    | 12 | 0,51      |
| 75  | TP075H | 37,10    | 28    | 12 | 0,80      |
| 90  | TP090H | 48,20    | 16    | 12 | 1,50      |
| 110 | TP110H | 71,50    | 7     | 16 | 2,30      |
| 125 | TP125H | 118,40   | 5     | 16 | 3,10      |
| 140 | TP140H | 166,60   | 70    | 1  | 4,14      |
| 160 | TP160H | 223,70   | 48    | 1  | 6,50      |
| 180 | TP180H | 384,10   | 35    | 1  | 7,75      |
| 200 | TP200H | 506,90   | 29    | 1  | 10,60     |
| 225 | TP225H | 624,80   | 20    | 1  | 14,70     |
| 250 | TP250H | 1027,20  | 14    | 1  | 21,00     |
| 280 | TP280H | 1430,70  | 9     | 1  | 29,40     |
| 315 | TP315H | 1717,60  | 7     | 1  | 41,00     |
| 355 | TP355H | 2187,90  | 6     | 1  | 55,00     |
| 400 | TP400H | 2759,20  | 4     | 1  | 66,00     |
| 450 | TP450H | 4254,30  | 2     | 1  | 109,20    |
| 500 | TP500H | 5688,60  | 2     | 1  | 146,20    |
| 560 | TP560H | 9.500,00 | 1     | 1  | 208,60    |
| 630 | TP630H | €...     | 1     | 1  | 275,00    |

Altre misure e/o SDR a richiesta  
 €...: Prezzo a richiesta



## Ti 90° ridotta codolo lungo

Fabbricato mediante stampaggio

### SDR17 PN10

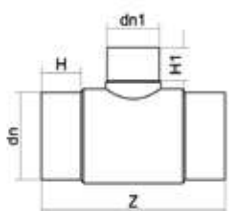

\* in fase di realizzazione

| dn   | dn1 | codice     | €      | Q Box | CP | Peso [kg] |
|------|-----|------------|--------|-------|----|-----------|
| 90   | 50  | TRP090050B | 27,60  | 20    | 12 | 0,60      |
| 90   | 63  | TRP090063B | 27,60  | 17    | 12 | 0,70      |
| 110  | 50  | TRP110050B | 40,60  | 13    | 12 | 1,03      |
| 110  | 63  | TRP110063B | 40,60  | 8     | 16 | 1,10      |
| 110  | 90  | TRP110090B | 40,60  | 7     | 16 | 1,20      |
| 125  | 63  | TRP125063B | 61,40  | 6     | 16 | 1,38      |
| 125  | 90  | TRP125090B | 61,40  | 6     | 16 | 1,40      |
| 140  | 63  | TRP140063B | 89,70  | 3     | 16 | 1,87      |
| 140  | 90  | TRP140090B | 89,70  | 70    | 1  | 2,00      |
| 160  | 63  | TRP160063B | 113,70 | 60    | 1  | 2,60      |
| 160  | 90  | TRP160090B | 113,70 | 54    | 1  | 2,69      |
| 160  | 110 | TRP160110B | 113,70 | 54    | 1  | 2,75      |
| 160  | 125 | TRP160125B | 113,70 | 50    | 1  | 2,00      |
| *180 | 63  | TRP180063B | 152,60 | 42    | 1  | 4,36      |
| 180  | 90  | TRP180090B | 152,60 | 40    | 1  | 3,70      |
| *180 | 110 | TRP180110B | 152,60 | 40    | 1  | 4,45      |
| 180  | 125 | TRP180125B | 152,60 | 35    | 1  | 3,78      |
| 200  | 63  | TRP200063B | 225,20 | 32    | 1  | 4,70      |
| 200  | 90  | TRP200090B | 225,20 | 32    | 1  | 4,54      |
| 200  | 110 | TRP200110B | 225,20 | 30    | 1  | 4,62      |
| *200 | 125 | TRP200125B | 225,20 | 30    | 1  | 6,18      |
| 200  | 160 | TRP200160B | 225,20 | 30    | 1  | 4,90      |
| *200 | 180 | TRP200180B | 225,20 | 29    | 1  | 6,30      |
| 225  | 90  | TRP225090B | 271,10 | 23    | 1  | 6,48      |
| *225 | 110 | TRP225110B | 271,10 | -     | -  | 6,52      |
| 225  | 125 | TRP225125B | 271,10 | 22    | 1  | 6,80      |
| 225  | 160 | TRP225160B | 271,10 | 20    | 1  | 6,80      |
| 225  | 180 | TRP225180B | 271,10 | 20    | 1  | 7,00      |
| 250  | 110 | TRP250110B | 442,50 | 17    | 1  | 9,80      |
| 250  | 125 | TRP250125B | 442,50 | 16    | 1  | 9,60      |
| 250  | 160 | TRP250160B | 442,50 | 15    | 1  | 10,70     |
| 250  | 180 | TRP250180B | 442,50 | 16    | 1  | 10,30     |
| *250 | 200 | TRP250200B | 442,50 | 15    | 1  | 12,20     |
| 280  | 110 | TRP280110B | 585,30 | 12    | 1  | 13,00     |
| *280 | 225 | TRP280225B | 585,30 | -     | -  | 13,50     |
| 315  | 110 | TRP315110B | 703,80 | 10    | 1  | 17,80     |
| *315 | 125 | TRP315125B | 703,80 | 9     | 1  | 18,70     |
| 315  | 160 | TRP315160B | 703,80 | 9     | 1  | 17,80     |
| 315  | 180 | TRP315180B | 703,80 | 9     | 1  | 18,30     |
| 315  | 200 | TRP315200B | 703,80 | 9     | 1  | 18,30     |
| 315  | 225 | TRP315225B | 703,80 | 8     | 1  | 18,30     |

Continua



## Ti 90° ridotta codolo lungo

Fabbricato mediante stampaggio

**SDR17 PN10**

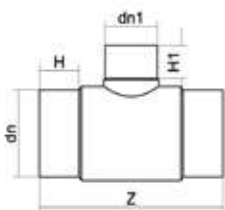

\* in fase di realizzazione

| dn   | dn1 | codice     | €       | Q Box | CP | Peso [kg] |
|------|-----|------------|---------|-------|----|-----------|
| 355  | 110 | TRP355110B | 1124,40 | 9     | 1  | 20,65     |
| 355  | 160 | TRP355160B | 1124,40 | 8     | 1  | 20,40     |
| *355 | 200 | TRP355200B | 1124,40 | 9     | 1  | 21,80     |
| 355  | 225 | TRP355225B | 1124,40 | 7     | 1  | 21,25     |
| 355  | 250 | TRP355250B | 1124,40 | 7     | 1  | 22,40     |
| 400  | 110 | TRP400110B | 1723,60 | 6     | 1  | 29,20     |
| 400  | 160 | TRP400160B | 1723,60 | 5     | 1  | 29,60     |
| 400  | 225 | TRP400225B | 1723,60 | 5     | 1  | 29,40     |
| 450  | 160 | TRP450160B | 2211,10 | 4     | 1  | 32,40     |
| 450  | 225 | TRP450225B | 2211,10 | 4     | 1  | 39,80     |
| 450  | 315 | TRP450315B | 2211,10 | 3     | 1  | 48,60     |
| 500  | 160 | TRP500160B | 3069,30 | 4     | 1  | 41,40     |
| *500 | 200 | TRP500200B | 3069,30 | -     | -  | 47,00     |
| 500  | 250 | TRP500250B | 3069,30 | 3     | 1  | 48,80     |
| 500  | 315 | TRP500315B | 3069,30 | 2     | 1  | 58,20     |
| *560 | 250 | TRP560250B | 3771,80 | 2     | 1  | 69,80     |
| 630  | 160 | TRP630160B | 5202,30 | 2     | 1  | 68,20     |
| *630 | 250 | TRP630250B | 5202,30 | 2     | 1  | 75,80     |
| *630 | 315 | TRP630315B | 5202,30 | 2     | 1  | 92,00     |

Altre misure e/o SDR a richiesta  
 €...: Prezzo a richiesta



## Ti 90° ridotta codolo lungo

Fabbricato mediante stampaggio

### SDR11 PN16

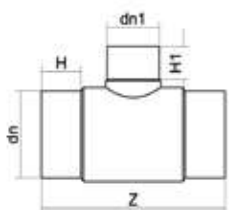

\* in fase di realizzazione

| dn   | dn1 | codice     | €      | Q Box | CP | Peso [kg] |
|------|-----|------------|--------|-------|----|-----------|
| 90   | 50  | TRP090050C | 30,10  | 20    | 12 | 0,85      |
| 90   | 63  | TRP090063C | 30,10  | 18    | 12 | 1,00      |
| 110  | 50  | TRP110050C | 44,50  | 13    | 12 | 1,40      |
| 110  | 63  | TRP110063C | 44,50  | 8     | 16 | 1,40      |
| 110  | 90  | TRP110090C | 44,50  | 7     | 16 | 1,50      |
| 125  | 63  | TRP125063C | 67,50  | 6     | 16 | 1,80      |
| 125  | 90  | TRP125090C | 67,50  | 6     | 16 | 1,98      |
| 140  | 63  | TRP140063C | 98,50  | 4     | 16 | 2,50      |
| 140  | 90  | TRP140090C | 98,50  | 4     | 16 | 2,70      |
| 160  | 63  | TRP160063C | 124,80 | 60    | 1  | 3,60      |
| 160  | 90  | TRP160090C | 124,80 | 54    | 1  | 3,57      |
| 160  | 110 | TRP160110C | 124,80 | 54    | 1  | 3,72      |
| 160  | 125 | TRP160125C | 124,80 | 54    | 1  | 3,82      |
| 180  | 63  | TRP180063C | 167,70 | 42    | 1  | 4,63      |
| 180  | 90  | TRP180090C | 167,70 | 40    | 1  | 4,80      |
| 180  | 110 | TRP180110C | 167,70 | 40    | 1  | 4,85      |
| 180  | 125 | TRP180125C | 167,70 | 40    | 1  | 5,10      |
| 200  | 63  | TRP200063C | 247,50 | 32    | 1  | 6,19      |
| 200  | 90  | TRP200090C | 247,50 | 32    | 1  | 6,32      |
| 200  | 110 | TRP200110C | 247,50 | 30    | 1  | 6,40      |
| 200  | 125 | TRP200125C | 247,50 | 30    | 1  | 6,52      |
| 200  | 160 | TRP200160C | 247,50 | 30    | 1  | 6,85      |
| 200  | 180 | TRP200180C | 247,50 | 29    | 1  | 6,60      |
| 225  | 90  | TRP225090C | 297,90 | 26    | 1  | 9,04      |
| 225  | 110 | TRP225110C | 297,90 | 26    | 1  | 9,12      |
| 225  | 125 | TRP225125C | 297,90 | 24    | 1  | 9,20      |
| 225  | 160 | TRP225160C | 297,90 | 20    | 1  | 9,60      |
| 225  | 180 | TRP225180C | 297,90 | 20    | 1  | 9,60      |
| 250  | 110 | TRP250110C | 486,30 | 17    | 1  | 12,40     |
| 250  | 125 | TRP250125C | 486,30 | 16    | 1  | 12,40     |
| 250  | 160 | TRP250160C | 486,30 | 16    | 1  | 12,90     |
| 250  | 180 | TRP250180C | 486,30 | 16    | 1  | 13,20     |
| 250  | 200 | TRP250200C | 486,30 | 15    | 1  | 13,40     |
| 280  | 110 | TRP280110C | 644,20 | 12    | 1  | 18,00     |
| *280 | 225 | TRP280225C | 644,20 | -     | -  | 18,50     |

Continua



## Ti 90° ridotta codolo lungo

Fabbricato mediante stampaggio

### SDR11 PN16

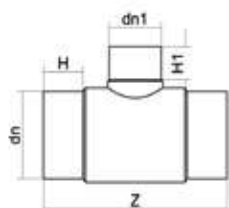

\* in fase di realizzazione

### SDR9 PN20

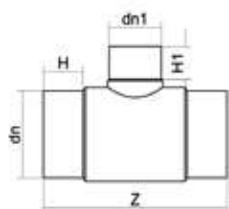

\* in fase di realizzazione

| dn  | dn1 | codice     | €       | Q Box | CP | Peso [kg] |
|-----|-----|------------|---------|-------|----|-----------|
| 315 | 110 | TRP315110C | 774,30  | 10    | 1  | 23,90     |
| 315 | 125 | TRP315125C | 774,30  | 10    | 1  | 24,50     |
| 315 | 160 | TRP315160C | 774,30  | 9     | 1  | 24,40     |
| 315 | 180 | TRP315180C | 774,30  | 9     | 1  | 24,80     |
| 315 | 200 | TRP315200C | 774,30  | 9     | 1  | 24,80     |
| 315 | 225 | TRP315225C | 774,30  | 8     | 1  | 25,00     |
| 355 | 110 | TRP355110C | 1495,10 | 9     | 1  | 28,40     |
| 355 | 160 | TRP355160C | 1495,10 | 8     | 1  | 28,40     |
| 355 | 200 | TRP355200C | 1495,10 | 8     | 1  | 29,40     |
| 355 | 225 | TRP355225C | 1495,10 | 7     | 1  | 29,00     |
| 355 | 250 | TRP355250C | 1495,70 | 7     | 1  | 31,20     |
| 400 | 110 | TRP400110C | 2081,00 | 6     | 1  | 39,00     |
| 400 | 160 | TRP400160C | 2081,00 | 5     | 1  | 38,80     |
| 400 | 225 | TRP400225C | 2081,00 | 5     | 1  | 39,60     |
| 450 | 160 | TRP450160C | 2731,40 | 4     | 1  | 42,40     |
| 450 | 225 | TRP450225C | 2731,40 | 4     | 1  | 52,80     |
| 450 | 315 | TRP450315C | 2731,40 | 3     | 1  | 63,40     |
| 500 | 160 | TRP500160C | 3771,80 | 4     | 1  | 55,40     |
| 500 | 200 | TRP500200C | 3771,80 | 3     | 1  | 64,00     |
| 500 | 250 | TRP500250C | 3771,80 | 3     | 1  | 64,60     |
| 500 | 315 | TRP500315C | 3771,80 | 2     | 1  | 78,40     |
| 560 | 250 | TRP560250C | 4942,20 | 2     | 1  | 96,80     |
| 630 | 160 | TRP630160C | 6763,10 | 2     | 1  | 95,00     |
| 630 | 250 | TRP630250C | 6763,10 | 2     | 1  | 104,00    |
| 630 | 315 | TRP630315C | 6763,10 | 2     | 1  | 124,60    |

| dn   | dn1 | codice     | €       | Q Box | CP | Peso [kg] |
|------|-----|------------|---------|-------|----|-----------|
| *110 | 63  | TRP110063G | 85,20   | -     | -  | 1,50      |
| *110 | 90  | TRP110090G | 85,20   | -     | -  | 1,70      |
| *125 | 63  | TRP125063G | 133,80  | 6     | 16 | 2,10      |
| *125 | 90  | TRP125090G | 133,80  | 6     | 16 | 2,20      |
| *140 | 63  | TRP140063G | 193,00  | 4     | 16 | 3,20      |
| 160  | 110 | TRP160110G | 338,10  | 54    | 1  | 4,70      |
| 200  | 110 | TRP200110G | 578,90  | 30    | 1  | 7,80      |
| 225  | 110 | TRP225110G | 711,20  | 24    | 1  | 11,10     |
| 225  | 160 | TRP225160G | 711,20  | -     | -  | 11,60     |
| 250  | 110 | TRP250110G | 1170,60 | 17    | 1  | 14,40     |
| 250  | 160 | TRP250160G | 1170,60 | 16    | 1  | 15,20     |
| 250  | 200 | TRP250200G | 1170,60 | 15    | 1  | 15,70     |
| 280  | 110 | TRP280110G | 1628,90 | 12    | 1  | 20,60     |
| 280  | 225 | TRP280225G | 1628,90 | 10    | 1  | 22,60     |

Continua

Altre misure e/o SDR a richiesta  
€...: Prezzo a richiesta



## Ti 90° ridotta codolo lungo

Fabbricato mediante stampaggio

### SDR9 PN20

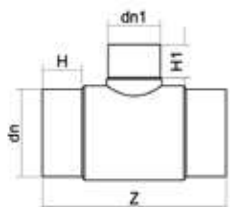

\* in fase di realizzazione

### SDR7,4 PN25

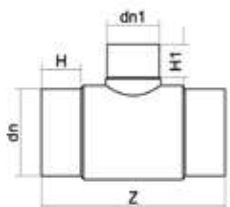

\* in fase di realizzazione

| dn   | dn1 | codice     | €       | Q Box | CP | Peso [kg] |
|------|-----|------------|---------|-------|----|-----------|
| 315  | 110 | TRP315110G | 1701,70 | 10    | 1  | 28,70     |
| 315  | 160 | TRP315160G | 1701,70 | 9     | 1  | 28,90     |
| 315  | 200 | TRP315200G | 1701,70 | 9     | 1  | 29,40     |
| 315  | 225 | TRP315225G | 1701,70 | 8     | 1  | 29,70     |
| 355  | 160 | TRP355160G | 1871,90 | 8     | 1  | 38,10     |
| 355  | 200 | TRP355200G | 1871,90 | 8     | 1  | 34,00     |
| 400  | 110 | TRP400110G | 2601,30 | 6     | 1  | 45,20     |
| 400  | 160 | TRP400160G | 2601,30 | 5     | 1  | 48,30     |
| 400  | 225 | TRP400225G | 2601,30 | 5     | 1  | 46,20     |
| 450  | 160 | TRP450160G | 3690,30 | 4     | 1  | 49,40     |
| 450  | 225 | TRP450225G | 3690,30 | 4     | 1  | 62,80     |
| *450 | 315 | TRP450315G | 3690,30 | 3     | 1  | 74,50     |
| 560  | 250 | TRP560250G | 5263,10 | 1     | 1  | 125,00    |

| dn   | dn1 | codice     | €       | Q Box | CP | Peso [kg] |
|------|-----|------------|---------|-------|----|-----------|
| 110  | 63  | TRP110063H | 90,00   | 8     | 12 | 1,90      |
| *110 | 90  | TRP110090H | 90,00   | -     | -  | 1,85      |
| 125  | 63  | TRP125063H | 136,20  | 6     | 16 | 2,50      |
| 125  | 90  | TRP125090H | 136,20  | 6     | 16 | 2,70      |
| 140  | 63  | TRP140063H | 198,50  | 4     | 16 | 3,75      |
| 160  | 110 | TRP160110H | 363,50  | 54    | 1  | 5,10      |
| *200 | 110 | TRP200110H | 583,50  | -     | -  | 8,25      |
| *225 | 110 | TRP225110H | 718,40  | -     | -  | 13,30     |
| *225 | 160 | TRP225160H | 718,40  | -     | -  | 12,05     |
| *250 | 110 | TRP250110H | 1180,30 | 16    | 1  | 14,90     |
| 250  | 160 | TRP250160H | 1180,30 | 16    | 1  | 18,40     |
| *250 | 200 | TRP250200H | 1180,30 | -     | -  | 16,25     |
| 280  | 110 | TRP280110H | 1640,90 | -     | -  | 24,90     |
| 280  | 225 | TRP280225H | 1640,90 | -     | -  | 27,10     |
| *315 | 110 | TRP315110H | 1717,60 | -     | -  | 34,10     |
| 315  | 160 | TRP315160H | 1717,60 | 9     | 1  | 34,80     |
| *315 | 200 | TRP315200H | 1717,60 | -     | -  | 36,80     |
| *315 | 225 | TRP315225H | 1717,60 | -     | -  | 55,80     |
| 355  | 160 | TRP355160H | 2187,90 | 8     | 1  | 40,20     |
| *355 | 200 | TRP355200H | 2187,90 | -     | -  | 34,60     |
| *400 | 110 | TRP400110H | 2759,20 | -     | -  | 47,60     |
| 400  | 160 | TRP400160H | 2759,20 | 5     | 1  | 52,60     |
| 400  | 225 | TRP400225H | 2759,20 | 5     | 1  | 55,00     |
| 450  | 160 | TRP450160H | 4254,30 | 4     | 1  | 59,30     |
| *450 | 225 | TRP450225H | 4254,30 | -     | -  | 74,40     |
| *450 | 315 | TRP450315H | 4254,30 | 3     | 1  | 89,40     |
| *560 | 250 | TRP560250H | 5688,60 | 2     | 1  | 162,00    |

Altre misure e/o SDR a richiesta  
€...: Prezzo a richiesta



## Croce codolo lungo

Fabbricato mediante saldatura

### SDR17 PN10

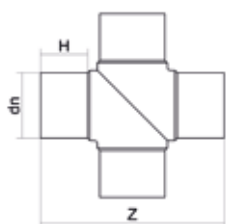

| dn   | codice  | €       | Q Box | CP | Peso [kg] |
|------|---------|---------|-------|----|-----------|
| 63   | CRP063B | 31,10   | -     | -  | -         |
| 75   | CRP075B | 46,70   | -     | -  | -         |
| 90   | CRP090B | 72,20   | -     | -  | -         |
| 110  | CRP110B | 108,40  | -     | -  | -         |
| *125 | CRP125B | 163,10  | 60    | 1  | 2,61      |
| 140  | CRP140B | 240,70  | -     | -  | -         |
| 160  | CRP160B | 275,40  | -     | -  | -         |
| 180  | CRP180B | 335,60  | -     | -  | -         |
| 200  | CRP200B | 498,60  | -     | -  | -         |
| 225  | CRP225B | 601,80  | -     | -  | -         |
| 250  | CRP250B | 982,70  | -     | -  | -         |
| 280  | CRP280B | 1524,20 | -     | -  | -         |
| 315  | CRP315B | 1577,70 | -     | -  | -         |
| 355  | CRP355B | 2139,30 | -     | -  | -         |

\* Fabbricato mediante stampaggio

### SDR11 PN16

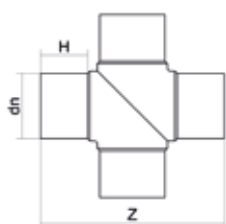

| dn   | codice  | €       | Q Box | CP | Peso [kg] |
|------|---------|---------|-------|----|-----------|
| 63   | CRP063C | 34,80   | -     | -  | -         |
| 75   | CRP075C | 52,20   | -     | -  | -         |
| 90   | CRP090C | 80,20   | -     | -  | -         |
| 110  | CRP110C | 120,40  | -     | -  | -         |
| *125 | CRP125C | 180,50  | 60    | 1  | 2,61      |
| 140  | CRP140C | 267,40  | -     | -  | -         |
| 160  | CRP160C | 303,60  | 2     | 12 | 5,40      |
| 180  | CRP180C | 371,80  | -     | -  | -         |
| 200  | CRP200C | 548,30  | -     | -  | -         |
| 225  | CRP225C | 628,40  | -     | -  | -         |
| 250  | CRP250C | 1096,40 | -     | -  | -         |
| 280  | CRP280C | 1684,70 | -     | -  | -         |
| 315  | CRP315C | 1724,80 | -     | -  | -         |
| 355  | CRP355C | 2607,30 | -     | -  | -         |

\* Fabbricato mediante stampaggio

Altre misure e/o SDR a richiesta  
 €...: Prezzo a richiesta





## Croce codolo lungo

Fabbricato mediante saldatura

**SDR7,4 PN25**

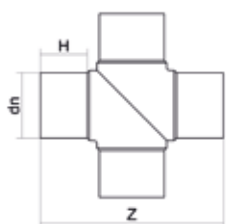

| dn  | codice  | €       | Q Box | CP | Peso [kg] |
|-----|---------|---------|-------|----|-----------|
| 63  | CRP063H | 51,00   | -     | -  | -         |
| 75  | CRP075H | 80,20   | -     | -  | -         |
| 90  | CRP090H | 116,30  | -     | -  | -         |
| 110 | CRP110H | 173,90  | -     | -  | -         |
| 125 | CRP125H | 287,40  | -     | -  | -         |
| 140 | CRP140H | 403,70  | -     | -  | -         |
| 160 | CRP160H | 548,30  | -     | -  | -         |
| 180 | CRP180H | 922,60  | -     | -  | -         |
| 200 | CRP200H | 1243,50 | -     | -  | -         |
| 225 | CRP225H | 1604,50 | -     | -  | -         |
| 250 | CRP250H | 2513,70 | -     | -  | -         |
| 280 | CRP280H | 3476,40 | -     | -  | -         |
| 315 | CRP315H | 4144,90 | -     | -  | -         |

Stampati



## Croce ridotta codolo lungo

Fabbricato mediante stampaggio

**SDR11 PN16**

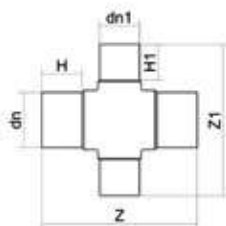

| dn  | dn1 | codice     | €      | Q Box | CP | Peso [kg] |
|-----|-----|------------|--------|-------|----|-----------|
| 125 | 90  | CRP125090C | 187,20 | 60    | 1  | 2,14      |

Altre misure e/o SDR a richiesta  
 €...: Prezzo a richiesta



## Y codolo lungo

Fabbricato mediante stampaggio

**SDR11 PN16**

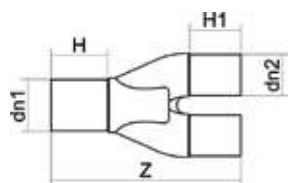

| dn1 | dn2 | codice     | €     | Q Box | CP | Peso [kg] |
|-----|-----|------------|-------|-------|----|-----------|
| 32  | 25  | YRP032025C | 26,50 | 120   | 16 | 0,08      |
| 40  | 32  | YRP040032C | 28,10 | 100   | 16 | 0,12      |
| 50  | 40  | YRP050040C | 29,40 | 50    | 16 | 0,18      |



## Ti 45° codolo lungo

Fabbricato mediante stampaggio

### SDR17 PN10

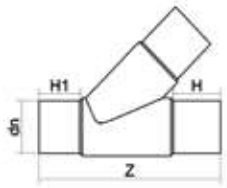

| dn  | codice  | €      | Q Box | CP | Peso [kg] |
|-----|---------|--------|-------|----|-----------|
| 63  | T4P063B | 24,00  | 16    | 16 | 0,50      |
| 75  | T4P075B | 40,10  | 18    | 12 | 0,75      |
| 90  | T4P090B | 46,70  | 10    | 12 | 1,20      |
| 110 | T4P110B | 70,90  | 80    | 1  | 1,90      |
| 125 | T4P125B | 119,00 | 56    | 1  | 2,50      |
| 140 | T4P140B | 173,90 | 42    | 1  | 3,54      |
| 160 | T4P160B | 226,10 | 30    | 1  | 5,10      |

### SDR11 PN16

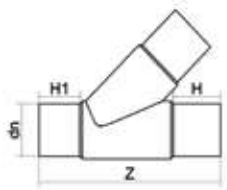

| dn  | codice  | €      | Q Box | CP | Peso [kg] |
|-----|---------|--------|-------|----|-----------|
| 63  | T4P063C | 26,80  | 16    | 16 | 0,61      |
| 75  | T4P075C | 42,80  | 18    | 12 | 0,90      |
| 90  | T4P090C | 52,20  | 130   | 1  | 1,50      |
| 110 | T4P110C | 77,60  | 90    | 1  | 2,40      |
| 125 | T4P125C | 131,00 | 64    | 1  | 3,50      |
| 140 | T4P140C | 193,90 | 42    | 1  | 4,94      |
| 160 | T4P160C | 248,60 | 30    | 1  | 6,70      |



## Gomito 90° codolo lungo

Fabbricato mediante stampaggio

### SDR17 PN10

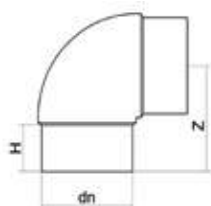

\* in fase di realizzazione

| dn    | codice  | €       | Q Box | CP | Peso [kg] |
|-------|---------|---------|-------|----|-----------|
| 63    | G9P063B | 9,80    | 54    | 12 | 0,23      |
| 75    | G9P075B | 13,50   | 28    | 16 | 0,36      |
| 90    | G9P090B | 17,20   | 20    | 12 | 0,61      |
| 110   | G9P110B | 32,60   | 15    | 12 | 0,90      |
| 125   | G9P125B | 46,00   | 8     | 16 | 1,40      |
| 140   | G9P140B | 63,30   | 6     | 12 | 1,72      |
| 160   | G9P160B | 69,30   | 5     | 12 | 2,50      |
| 180   | G9P180B | 84,50   | 50    | 1  | 2,85      |
| 200   | G9P200B | 117,60  | 40    | 1  | 4,40      |
| 225   | G9P225B | 158,40  | 26    | 1  | 5,60      |
| 250   | G9P250B | 225,20  | 20    | 1  | 8,40      |
| 280   | G9P280B | 480,00  | 14    | 1  | 12,10     |
| 315   | G9P315B | 494,80  | 9     | 1  | 16,20     |
| 355   | G9P355B | 887,30  | 8     | 1  | 18,20     |
| 400   | G9P400B | 1288,50 | 1     | 4  | 28,20     |
| * 450 | G9P450B | €...    | -     | -  | -         |
| * 500 | G9P500B | €...    | 1     | 2  | 80,00     |
| * 560 | G9P560B | €...    | -     | -  | -         |
| 630   | G9P630B | €...    | -     | -  | -         |

### SDR11 PN16

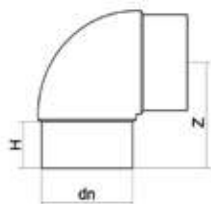

\* in fase di realizzazione

| dn    | codice  | €        | Q Box | CP | Peso [kg] |
|-------|---------|----------|-------|----|-----------|
| 20    | G9P020C | 4,80     | -     | -  | 0,02      |
| 25    | G9P025C | 4,80     | 100   | 60 | 0,04      |
| 32    | G9P032C | 5,30     | 60    | 60 | 0,05      |
| 40    | G9P040C | 5,70     | 60    | 32 | 0,08      |
| 50    | G9P050C | 7,90     | 46    | 32 | 0,13      |
| 63    | G9P063C | 10,60    | 70    | 12 | 0,28      |
| 75    | G9P075C | 14,60    | 32    | 16 | 0,43      |
| 90    | G9P090C | 18,30    | 24    | 12 | 0,80      |
| 110   | G9P110C | 34,70    | 15    | 12 | 1,18      |
| 125   | G9P125C | 49,00    | 8     | 16 | 1,70      |
| 140   | G9P140C | 67,50    | 6     | 12 | 2,28      |
| 160   | G9P160C | 74,20    | 5     | 12 | 3,16      |
| 180   | G9P180C | 105,80   | 50    | 1  | 4,20      |
| 200   | G9P200C | 139,10   | 40    | 1  | 5,80      |
| 225   | G9P225C | 169,10   | 28    | 1  | 7,60      |
| 250   | G9P250C | 257,70   | 20    | 1  | 11,30     |
| 280   | G9P280C | 513,00   | 14    | 1  | 16,20     |
| 315   | G9P315C | 527,50   | 9     | 1  | 21,40     |
| 355   | G9P355C | 1166,90  | 8     | 1  | 24,40     |
| 400   | G9P400C | 1762,40  | 1     | 4  | 38,00     |
| * 450 | G9P450C | €...     | -     | -  | -         |
| 500   | G9P500C | 4.050,00 | 1     | 2  | 86,4      |
| * 560 | G9P560C | €...     | -     | -  | -         |
| 630   | G9P630C | 6.800,00 | 1     | 1  | 147,00    |

Altre misure e/o SDR a richiesta  
€...: Prezzo a richiesta



## Gomito 90° codolo lungo

Fabbricato mediante stampaggio

### SDR9 PN20

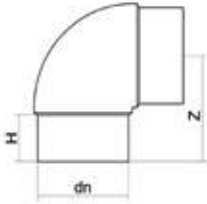

\* in fase di realizzazione

| dn    | codice  | €        | Q Box | CP | Peso [kg] |
|-------|---------|----------|-------|----|-----------|
| 63    | G9P063G | 21,80    | 70    | 12 | 0,37      |
| 75    | G9P075G | 31,80    | 32    | 16 | 0,50      |
| 90    | G9P090G | 48,00    | 24    | 12 | 0,85      |
| 110   | G9P110G | 75,40    | 15    | 12 | 1,36      |
| 125   | G9P125G | 144,80   | 8     | 16 | 2,00      |
| 140   | G9P140G | 183,50   | 6     | 12 | 2,97      |
| 160   | G9P160G | 231,00   | 5     | 12 | 3,80      |
| 180   | G9P180G | 301,50   | 4     | 12 | 5,04      |
| 200   | G9P200G | 356,30   | 40    | 1  | 6,80      |
| 225   | G9P225G | 464,40   | 28    | 1  | 9,30      |
| 250   | G9P250G | 724,50   | 20    | 1  | 12,60     |
| 280   | G9P280G | 1045,40  | 14    | 1  | 18,80     |
| 315   | G9P315G | 1203,40  | 9     | 1  | 24,20     |
| 355   | G9P355G | 1944,80  | 8     | 1  | 29,00     |
| 400   | G9P400G | 2674,10  | 1     | 4  | 43,80     |
| * 450 | G9P450G | €...     | -     | -  | -         |
| 500   | G9P500G | 4.600,00 | 1     | 2  | 98,2      |
| * 560 | G9P560G | €...     | -     | -  | -         |
| * 630 | G9P630G | €...     | -     | -  | 160,00    |

### SDR7,4 PN25

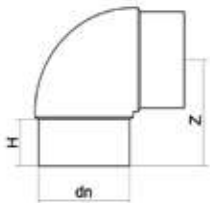

\* in fase di realizzazione

| dn    | codice  | €       | Q Box | CP | Peso [kg] |
|-------|---------|---------|-------|----|-----------|
| 25    | G9P025H | 9,30    | 100   | 60 | 0,04      |
| 32    | G9P032H | 9,80    | 60    | 60 | 0,06      |
| 40    | G9P040H | 10,50   | 60    | 32 | 0,11      |
| 50    | G9P050H | 14,90   | 46    | 32 | 0,17      |
| 63    | G9P063H | 22,50   | 70    | 12 | 0,38      |
| 75    | G9P075H | 33,40   | 32    | 16 | 0,57      |
| 90    | G9P090H | 50,00   | 24    | 12 | 1,00      |
| 110   | G9P110H | 76,70   | 15    | 12 | 1,58      |
| 125   | G9P125H | 150,70  | 8     | 16 | 2,25      |
| 140   | G9P140H | 190,90  | 6     | 12 | 3,19      |
| 160   | G9P160H | 239,50  | 5     | 12 | 4,40      |
| 180   | G9P180H | 313,50  | 4     | 12 | 5,40      |
| 200   | G9P200H | 370,80  | 40    | 1  | 7,60      |
| 225   | G9P225H | 482,60  | 28    | 1  | 10,20     |
| 250   | G9P250H | 753,70  | 20    | 1  | 14,70     |
| 280   | G9P280H | 1086,60 | 14    | 1  | 21,50     |
| 315   | G9P315H | 1250,80 | 9     | 1  | 28,30     |
| 355   | G9P355H | 2042,00 | 8     | 1  | 34,60     |
| 400   | G9P400H | 2771,40 | 1     | 4  | 51,00     |
| * 450 | G9P450H | €...    | -     | -  | -         |
| * 500 | G9P500H | €...    | -     | -  | -         |

Altre misure e/o SDR a richiesta  
€...: Prezzo a richiesta



## Gomito 45° codolo lungo

Fabbricato mediante stampaggio

### SDR17 PN10

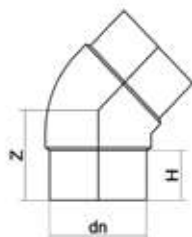

\* in fase di realizzazione

| dn    | codice  | €      | Q Box | CP | Peso [kg] |
|-------|---------|--------|-------|----|-----------|
| 63    | G4P063B | 9,80   | 56    | 16 | 0,18      |
| 75    | G4P075B | 12,90  | 45    | 12 | 0,25      |
| 90    | G4P090B | 16,30  | 21    | 16 | 0,40      |
| 110   | G4P110B | 31,60  | 12    | 16 | 0,64      |
| 125   | G4P125B | 45,70  | 7     | 16 | 1,10      |
| 140   | G4P140B | 57,80  | 7     | 12 | 1,36      |
| 160   | G4P160B | 67,50  | 6     | 12 | 1,90      |
| 180   | G4P180B | 79,40  | 62    | 1  | 2,40      |
| 200   | G4P200B | 108,30 | 50    | 1  | 3,20      |
| 225   | G4P225B | 139,80 | 32    | 1  | 4,30      |
| 250   | G4P250B | 193,40 | 28    | 1  | 5,85      |
| 280   | G4P280B | 405,90 | 14    | 1  | 8,80      |
| 315   | G4P315B | 420,60 | 12    | 1  | 11,80     |
| 355   | G4P355B | 644,20 | 12    | 1  | 13,70     |
| 400   | G4P400B | 887,30 | 3     | 2  | 18,70     |
| * 450 | G4P450B | €...   | -     | -  | -         |
| * 500 | G4P500B | €...   | -     | -  | -         |
| * 560 | G4P560B | €...   | -     | -  | -         |
| * 630 | G4P630B | €...   | -     | -  | -         |

### SDR11 PN16

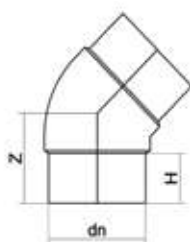

\* in fase di realizzazione

| dn    | codice  | €        | Q Box | CP | Peso [kg] |
|-------|---------|----------|-------|----|-----------|
| 20    | G4P020C | 6,70     | 39    | 46 | 0,02      |
| 25    | G4P025C | 6,70     | 40    | 49 | 0,03      |
| 32    | G4P032C | 6,70     | 70    | 60 | 0,04      |
| 40    | G4P040C | 6,70     | 70    | 32 | 0,08      |
| 50    | G4P050C | 7,10     | 46    | 32 | 0,14      |
| 63    | G4P063C | 10,80    | 62    | 16 | 0,22      |
| 75    | G4P075C | 14,10    | 60    | 12 | 0,35      |
| 90    | G4P090C | 17,90    | 22    | 16 | 0,51      |
| 110   | G4P110C | 34,80    | 12    | 16 | 0,90      |
| 125   | G4P125C | 50,40    | 7     | 16 | 1,50      |
| 140   | G4P140C | 63,50    | 8     | 12 | 2,00      |
| 160   | G4P160C | 74,20    | 6     | 12 | 2,80      |
| 180   | G4P180C | 87,30    | 62    | 1  | 3,20      |
| 200   | G4P200C | 119,10   | 50    | 1  | 4,50      |
| 225   | G4P225C | 153,10   | 32    | 1  | 6,10      |
| 250   | G4P250C | 212,80   | 28    | 1  | 7,00      |
| 280   | G4P280C | 446,10   | 14    | 1  | 11,60     |
| 315   | G4P315C | 460,70   | 12    | 1  | 16,00     |
| 355   | G4P355C | 899,50   | 12    | 1  | 19,40     |
| 400   | G4P400C | 1276,30  | 3     | 2  | 27,00     |
| * 450 | G4P450C | €...     | -     | -  | -         |
| 500   | G4P500C | 2.600,00 | -     | -  | -         |
| * 560 | G4P560C | €...     | -     | -  | -         |
| 630   | G4P630C | 4.800,00 | -     | -  | -         |

Altre misure e/o SDR a richiesta  
€...: Prezzo a richiesta



## Gomito 45° codolo lungo

Fabbricato mediante stampaggio

### SDR9 PN20

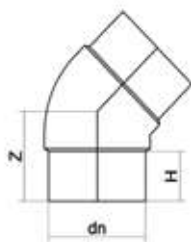

\* in fase di realizzazione

| dn    | codice  | €       | Q Box | CP | Peso [kg] |
|-------|---------|---------|-------|----|-----------|
| 63    | G4P063G | 21,00   | 62    | 16 | 0,25      |
| 75    | G4P075G | 29,10   | 60    | 12 | 0,40      |
| 90    | G4P090G | 41,80   | 22    | 16 | 0,60      |
| 110   | G4P110G | 69,60   | 12    | 16 | 1,15      |
| 125   | G4P125G | 148,30  | 7     | 16 | 1,95      |
| 140   | G4P140G | 188,40  | 8     | 12 | 2,40      |
| 160   | G4P160G | 218,80  | 6     | 12 | 3,42      |
| 180   | G4P180G | 314,90  | 62    | 1  | 4,16      |
| 200   | G4P200G | 331,90  | 50    | 1  | 5,10      |
| 225   | G4P225G | 459,40  | 32    | 1  | 6,80      |
| 250   | G4P250G | 607,80  | 28    | 1  | 8,95      |
| 280   | G4P280G | 931,00  | 14    | 1  | 13,75     |
| 315   | G4P315G | 1068,60 | 12    | 1  | 18,60     |
| 355   | G4P355G | 1397,90 | 12    | 1  | 23,20     |
| 400   | G4P400G | 2005,60 | 3     | 2  | 31,80     |
| * 450 | G4P450G | €...    | -     | -  | -         |
| * 500 | G4P500G | €...    | -     | -  | -         |
| * 560 | G4P560G | €...    | -     | -  | -         |
| * 630 | G4P630G | €...    | -     | -  | -         |

### SDR7,4 PN25

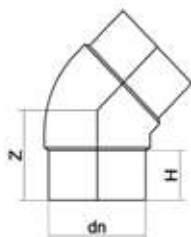

\* in fase di realizzazione

| dn    | codice  | €       | Q Box | CP | Peso [kg] |
|-------|---------|---------|-------|----|-----------|
| 40    | G4P040H | 11,60   | 70    | 32 | 0,10      |
| 50    | G4P050H | 16,10   | 46    | 32 | 0,18      |
| 63    | G4P063H | 21,80   | 62    | 16 | 0,29      |
| 75    | G4P075H | 30,50   | 60    | 12 | 0,46      |
| 90    | G4P090H | 43,80   | 22    | 16 | 0,69      |
| 110   | G4P110H | 73,00   | 12    | 16 | 1,30      |
| 125   | G4P125H | 155,60  | 7     | 16 | 2,10      |
| 140   | G4P140H | 198,20  | 8     | 12 | 2,70      |
| 160   | G4P160H | 228,60  | 6     | 12 | 3,66      |
| 180   | G4P180H | 330,60  | 62    | 1  | 4,40      |
| 200   | G4P200H | 347,70  | 50    | 1  | 6,00      |
| 225   | G4P225H | 481,30  | 32    | 1  | 7,90      |
| 250   | G4P250H | 636,90  | 28    | 1  | 10,70     |
| 280   | G4P280H | 976,20  | 14    | 1  | 15,80     |
| 315   | G4P315H | 1118,30 | 12    | 1  | 21,40     |
| 355   | G4P355H | 1458,70 | 12    | 1  | 25,80     |
| 400   | G4P400H | 2066,40 | 3     | 2  | 37,00     |
| * 450 | G4P450H | €...    | -     | -  | -         |
| * 500 | G4P500H | €...    | -     | -  | -         |

Altre misure e/o SDR a richiesta  
€...: Prezzo a richiesta



## Riduzione codolo lungo

Fabbricato mediante stampaggio

### SDR17 PN10

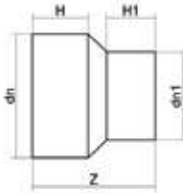

| dn           | dn1 | codice    | €      | Q Box | CP | Peso [kg] |
|--------------|-----|-----------|--------|-------|----|-----------|
| 110          | 50  | RP110050B | 15,10  | 45    | 12 | 0,30      |
| 110          | 63  | RP110063B | 15,10  | 45    | 12 | 0,39      |
| 110          | 75  | RP110075B | 15,10  | 45    | 12 | 0,49      |
| 110          | 90  | RP110090B | 15,10  | 36    | 12 | 0,60      |
| 125          | 63  | RP125063B | 21,40  | 30    | 16 | 0,60      |
| 125          | 75  | RP125075B | 21,40  | 30    | 16 | 0,50      |
| 125          | 90  | RP125090B | 21,40  | 30    | 16 | 0,52      |
| 125          | 110 | RP125110B | 21,40  | 24    | 12 | 0,60      |
| 140          | 90  | RP140090B | 33,30  | 24    | 12 | 0,80      |
| 140          | 110 | RP140110B | 33,30  | 24    | 12 | 0,82      |
| 140          | 125 | RP140125B | 33,30  | 18    | 12 | 1,10      |
| 160          | 90  | RP160090B | 40,20  | 16    | 12 | 1,05      |
| 160          | 110 | RP160110B | 40,20  | 16    | 12 | 0,82      |
| 160          | 125 | RP160125B | 40,20  | 16    | 12 | 1,10      |
| 160          | 140 | RP160140B | 40,20  | 8     | 16 | 1,10      |
| 180          | 63  | RP180063B | 46,40  | 6     | 16 | 1,10      |
| 180          | 110 | RP180110B | 46,40  | 6     | 16 | 1,15      |
| 180          | 125 | RP180125B | 46,40  | 6     | 16 | 1,20      |
| 180          | 140 | RP180140B | 46,40  | 12    | 12 | 1,80      |
| 180          | 160 | RP180160B | 46,40  | 6     | 16 | 2,00      |
| 200          | 90  | RP200090B | 60,80  | 6     | 16 | 2,10      |
| 200          | 140 | RP200140B | 60,80  | 6     | 16 | 1,60      |
| 200          | 160 | RP200160B | 60,80  | 6     | 16 | 1,96      |
| 200          | 180 | RP200180B | 60,80  | 4     | 16 | 2,30      |
| 225          | 110 | RP225110B | 82,70  | 96    | 1  | 2,80      |
| 225          | 160 | RP225160B | 82,70  | 126   | 1  | 2,40      |
| 225          | 180 | RP225180B | 82,70  | 108   | 1  | 2,40      |
| 225          | 200 | RP225200B | 82,70  | 72    | 1  | 2,90      |
| 250          | 180 | RP250180B | 111,00 | 84    | 1  | 2,80      |
| 250          | 200 | RP250200B | 111,00 | 84    | 1  | 3,60      |
| 250          | 225 | RP250225B | 111,00 | 60    | 1  | 3,40      |
| 315          | 225 | RP315225B | 182,00 | 40    | 1  | 6,50      |
| 315          | 250 | RP315250B | 182,00 | 40    | 1  | 7,40      |
| <b>N</b> 400 | 315 | RP400315B | 750,00 | -     | -  | 8,77      |





## Riduzione codolo lungo

Fabbricato mediante stampaggio

### SDR11 PN16

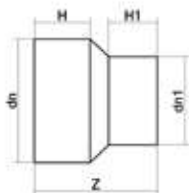

| dn  | dn1 | codice    | €     | Q Box | CP | Peso [kg] |
|-----|-----|-----------|-------|-------|----|-----------|
| 25  | 20  | RP025020C | 6,60  | -     | -  | 0,02      |
| 32  | 20  | RP032020C | 6,60  | -     | -  | 0,02      |
| 32  | 25  | RP032025C | 6,60  | 100   | 60 | 0,04      |
| 40  | 20  | RP040020C | 6,60  | -     | -  | 0,03      |
| 40  | 25  | RP040025C | 6,60  | 70    | 60 | 0,04      |
| 40  | 32  | RP040032C | 6,60  | 60    | 60 | 0,04      |
| 50  | 25  | RP050025C | 6,60  | 130   | 32 | 0,06      |
| 50  | 32  | RP050032C | 6,60  | 80    | 32 | 0,06      |
| 50  | 40  | RP050040C | 6,60  | 80    | 32 | 0,07      |
| 63  | 25  | RP063025C | 7,40  | 72    | 32 | 0,10      |
| 63  | 32  | RP063032C | 7,40  | 72    | 32 | 0,15      |
| 63  | 40  | RP063040C | 7,40  | 72    | 32 | 0,18      |
| 63  | 50  | RP063050C | 7,40  | 50    | 32 | 0,18      |
| 75  | 32  | RP075032C | 9,10  | 48    | 32 | 0,21      |
| 75  | 40  | RP075040C | 9,10  | 48    | 32 | 0,21      |
| 75  | 50  | RP075050C | 9,10  | 48    | 32 | 0,30      |
| 75  | 63  | RP075063C | 9,10  | 30    | 32 | 0,30      |
| 90  | 50  | RP090050C | 12,20 | 60    | 16 | 0,31      |
| 90  | 63  | RP090063C | 12,20 | 60    | 16 | 0,31      |
| 90  | 75  | RP090075C | 12,20 | 36    | 16 | 0,38      |
| 110 | 50  | RP110050C | 16,20 | 45    | 12 | 0,47      |
| 110 | 63  | RP110063C | 16,20 | 45    | 12 | 0,60      |
| 110 | 75  | RP110075C | 16,20 | 45    | 12 | 0,60      |
| 110 | 90  | RP110090C | 16,20 | 30    | 12 | 0,60      |

Stampati

Continua



## Riduzione codolo lungo

Fabbricato mediante stampaggio

**SDR11 PN16**

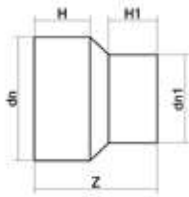

| dn           | dn1 | codice    | €      | Q Box | CP | Peso [kg] |
|--------------|-----|-----------|--------|-------|----|-----------|
| 125          | 63  | RP125063C | 22,80  | 26    | 16 | 0,71      |
| 125          | 75  | RP125075C | 22,80  | 26    | 16 | 0,61      |
| 125          | 90  | RP125090C | 22,80  | 30    | 16 | 0,71      |
| 125          | 110 | RP125110C | 22,80  | 24    | 12 | 0,83      |
| 140          | 90  | RP140090C | 35,40  | 24    | 12 | 0,94      |
| 140          | 110 | RP140110C | 35,40  | 24    | 12 | 0,94      |
| 140          | 125 | RP140125C | 35,40  | 18    | 12 | 1,11      |
| 160          | 90  | RP160090C | 43,10  | 16    | 12 | 1,20      |
| 160          | 110 | RP160110C | 43,10  | 16    | 12 | 1,20      |
| 160          | 125 | RP160125C | 43,10  | 16    | 12 | 1,60      |
| 160          | 140 | RP160140C | 43,10  | 8     | 16 | 1,40      |
| 180          | 63  | RP180063C | 49,40  | 6     | 16 | 1,60      |
| 180          | 110 | RP180110C | 49,40  | 6     | 16 | 1,80      |
| 180          | 125 | RP180125C | 49,40  | 6     | 16 | 1,80      |
| 180          | 140 | RP180140C | 49,40  | 12    | 12 | 2,20      |
| 180          | 160 | RP180160C | 49,40  | 6     | 16 | 2,20      |
| 200          | 90  | RP200090C | 64,90  | 6     | 16 | 2,20      |
| 200          | 140 | RP200140C | 64,90  | 6     | 16 | 2,40      |
| 200          | 160 | RP200160C | 64,90  | 6     | 16 | 2,21      |
| 200          | 180 | RP200180C | 64,90  | 6     | 16 | 2,66      |
| 225          | 110 | RP225110C | 88,50  | 96    | 1  | 3,20      |
| 225          | 160 | RP225160C | 88,50  | 108   | 1  | 3,40      |
| 225          | 180 | RP225180C | 88,50  | 72    | 1  | 3,40      |
| 225          | 200 | RP225200C | 88,50  | 72    | 1  | 3,80      |
| 250          | 180 | RP250180C | 125,80 | 84    | 1  | 4,40      |
| 250          | 200 | RP250200C | 125,80 | 56    | 1  | 4,60      |
| 250          | 225 | RP250225C | 125,80 | 60    | 1  | 4,80      |
| 315          | 225 | RP315225C | 206,60 | 40    | 1  | 10,40     |
| 315          | 250 | RP315250C | 206,60 | 40    | 1  | 11,80     |
| <b>N</b> 355 | 315 | RP355315C | 630,00 | 18    | 1  | 10,10     |



## Riduzione codolo lungo

Fabbricato mediante stampaggio

**SDR9 PN20**

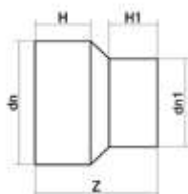

| dn       | dn1 | codice    | €         | Q Box  | CP | Peso [kg] |      |
|----------|-----|-----------|-----------|--------|----|-----------|------|
| 110      | 50  | RP110050G | 35,60     | 45     | 1  | 0,46      |      |
| 110      | 63  | RP110063G | 35,60     | 45     | 12 | 0,57      |      |
| 110      | 75  | RP110075G | 35,60     | 36     | 12 | 0,58      |      |
| 110      | 90  | RP110090G | 35,60     | 30     | 12 | 0,75      |      |
| 125      | 63  | RP125063G | 50,30     | 26     | 16 | 0,80      |      |
| 125      | 75  | RP125075G | 50,30     | 24     | 16 | 0,80      |      |
| 125      | 90  | RP125090G | 50,30     | 18     | 16 | 0,90      |      |
| 125      | 110 | RP125110G | 50,30     | 24     | 12 | 1,00      |      |
| 140      | 90  | RP140090G | 78,80     | 24     | 12 | 0,92      |      |
| 140      | 110 | RP140110G | 78,80     | 19     | 12 | 1,25      |      |
| 140      | 125 | RP140125G | 78,80     | 18     | 12 | 1,40      |      |
| 160      | 90  | RP160090G | 88,50     | 14     | 12 | 1,55      |      |
| 160      | 110 | RP160110G | 88,50     | 14     | 12 | 1,36      |      |
| 160      | 125 | RP160125G | 88,50     | 12     | 12 | 1,65      |      |
| 160      | 140 | RP160140G | 88,50     | 8      | 16 | 1,78      |      |
| 180      | 125 | RP180125G | 112,40    | 6      | 16 | 2,10      |      |
| 180      | 140 | RP180140G | 112,40    | 12     | 12 | 2,35      |      |
| 180      | 160 | RP180160G | 112,40    | 6      | 16 | 2,40      |      |
| 200      | 140 | RP200140G | 148,90    | 6      | 16 | 3,00      |      |
| 200      | 160 | RP200160G | 148,90    | 6      | 16 | 3,20      |      |
| 200      | 180 | RP200180G | 148,90    | 4      | 16 | 3,20      |      |
| 225      | 110 | RP225110G | 179,20    | 90     | 1  | 2,90      |      |
| 225      | 160 | RP225160G | 179,20    | 108    | 1  | 3,80      |      |
| 225      | 180 | RP225180G | 179,20    | 72     | 1  | 3,80      |      |
| 225      | 200 | RP225200G | 179,20    | 72     | 1  | 4,50      |      |
| <b>N</b> | 250 | 180       | RP250180G | 285,00 | -  | -         | 5,20 |
| <b>N</b> | 250 | 200       | RP250200G | 285,00 | -  | -         | 5,50 |
| 250      | 225 | RP250225G | 285,00    | 60     | 1  | 5,80      |      |

Stampati



## Riduzione codolo lungo

Fabbricato mediante stampaggio

**SDR7,4 PN25**

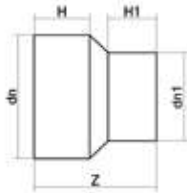

| dn           | dn1 | codice    | €      | Q Box | CP | Peso [kg] |
|--------------|-----|-----------|--------|-------|----|-----------|
| 40           | 25  | RP040025H | 13,40  | 70    | 60 | 0,06      |
| 40           | 32  | RP040032H | 13,40  | 60    | 60 | 0,06      |
| 50           | 25  | RP050025H | 13,40  | 130   | 32 | 0,08      |
| 50           | 32  | RP050032H | 13,40  | 80    | 32 | 0,09      |
| 50           | 40  | RP050040H | 13,40  | 80    | 32 | 0,09      |
| 63           | 25  | RP063025H | 16,90  | 72    | 32 | 0,18      |
| 63           | 32  | RP063032H | 16,90  | 72    | 32 | 0,18      |
| 63           | 40  | RP063040H | 16,90  | 72    | 32 | 0,20      |
| 63           | 50  | RP063050H | 16,90  | 50    | 32 | 0,21      |
| 75           | 32  | RP075032H | 21,30  | 44    | 32 | 0,24      |
| 75           | 40  | RP075040H | 21,30  | 48    | 32 | 0,25      |
| 75           | 50  | RP075050H | 21,30  | 48    | 32 | 0,29      |
| 75           | 63  | RP075063H | 21,30  | 30    | 32 | 0,30      |
| 90           | 50  | RP090050H | 28,10  | 60    | 16 | 0,30      |
| 90           | 63  | RP090063H | 28,10  | 60    | 16 | 0,32      |
| 90           | 75  | RP090075H | 28,10  | 36    | 16 | 0,47      |
| 110          | 50  | RP110050H | 37,30  | 45    | 12 | 0,57      |
| 110          | 63  | RP110063H | 37,30  | 36    | 12 | 0,68      |
| 110          | 75  | RP110075H | 37,30  | 36    | 12 | 0,71      |
| 110          | 90  | RP110090H | 37,30  | 30    | 12 | 0,90      |
| 125          | 63  | RP125063H | 52,60  | 26    | 16 | 0,88      |
| 125          | 75  | RP125075H | 52,60  | 24    | 16 | 1,00      |
| 125          | 90  | RP125090H | 52,60  | 18    | 16 | 1,00      |
| 125          | 110 | RP125110H | 52,60  | 24    | 12 | 1,09      |
| 140          | 90  | RP140090H | 82,40  | 24    | 12 | 1,14      |
| 140          | 110 | RP140110H | 82,40  | 19    | 12 | 1,40      |
| 140          | 125 | RP140125H | 82,40  | 18    | 12 | 1,50      |
| 160          | 90  | RP160090H | 92,70  | 14    | 12 | 1,70      |
| 160          | 110 | RP160110H | 92,70  | 14    | 12 | 1,88      |
| 160          | 125 | RP160125H | 92,70  | 12    | 12 | 1,95      |
| 160          | 140 | RP160140H | 92,70  | 8     | 16 | 2,05      |
| 180          | 125 | RP180125H | 117,60 | 6     | 16 | 2,27      |
| 180          | 140 | RP180140H | 117,60 | 12    | 12 | 2,40      |
| 180          | 160 | RP180160H | 117,60 | 6     | 16 | 2,56      |
| 200          | 140 | RP200140H | 155,60 | 6     | 16 | 3,20      |
| 200          | 160 | RP200160H | 155,60 | 6     | 16 | 3,60      |
| 200          | 180 | RP200180H | 155,60 | 4     | 16 | 3,60      |
| 225          | 160 | RP225160H | 187,20 | 108   | 1  | 4,20      |
| 225          | 180 | RP225180H | 187,20 | 4     | 12 | 4,20      |
| 225          | 200 | RP225200H | 187,20 | 72    | 1  | 5,20      |
| <b>N</b> 250 | 180 | RP250180H | 289,40 | -     | -  | 5,90      |
| <b>N</b> 250 | 200 | RP250200H | 289,40 | -     | -  | 6,20      |
| 250          | 225 | RP250225H | 289,40 | 60    | 1  | 6,50      |

Altre misure e/o SDR a richiesta  
 €...: Prezzo a richiesta



## Riduzione codolo corto

Fabbricato mediante stampaggio

Utilizzo solo mediante saldatura ad elementi termici per contatto (testa a testa)

### SDR26 PN6

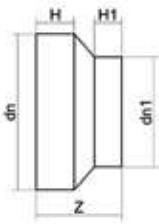

| dn   | dn1  | codice       | €       | Q Box | CP | Peso [kg] |
|------|------|--------------|---------|-------|----|-----------|
| 250  | 160  | RCP250160A   | 74,80   | 6     | 16 | 1,50      |
| 250  | 180  | RCP250180A   | 74,80   | 6     | 16 | 1,60      |
| 250  | 200  | RCP250200A   | 74,80   | -     | -  | 1,70      |
| 250  | 225  | RCP250225A   | 74,80   | -     | -  | 2,20      |
| 280  | 200  | RCP280200A   | 87,80   | -     | -  | 2,60      |
| 280  | 225  | RCP280225A   | 87,80   | 110   | 1  | 2,20      |
| 280  | 250  | RCP280250A   | 87,80   | 84    | 1  | 2,30      |
| 315  | 225  | RCP315225A   | 92,40   | 72    | 1  | 2,90      |
| 315  | 250  | RCP315250A   | 92,40   | -     | -  | 2,90      |
| 315  | 280  | RCP315280A   | 92,40   | 54    | 1  | 3,40      |
| 355  | 225  | RCP355225A   | 113,10  | 54    | 1  | 4,50      |
| 355  | 250  | RCP355250A   | 113,10  | -     | -  | 4,50      |
| 355  | 280  | RCP355280A   | 113,10  | 48    | 1  | 5,00      |
| 355  | 315  | RCP355315A   | 113,10  | -     | -  | 5,00      |
| 400  | 280  | RCP400280A   | 206,60  | -     | -  | 5,40      |
| 400  | 315  | RCP400315A   | 206,60  | 48    | 1  | 6,50      |
| 400  | 355  | RCP400355A   | 206,60  | 36    | 1  | 7,80      |
| 450  | 315  | RCP450315A   | 328,20  | 24    | 1  | 7,60      |
| 450  | 355  | RCP450355A   | 328,20  | 20    | 1  | 8,00      |
| 450  | 400  | RCP450400A   | 328,20  | 20    | 1  | 8,20      |
| 500  | 355  | RCP500355A   | 509,40  | 15    | 1  | 9,60      |
| 500  | 400  | RCP500400A   | 509,40  | 18    | 1  | 9,40      |
| 500  | 450  | RCP500450A   | 509,40  | 35    | 1  | 9,10      |
| 560  | 400  | RCP560400A   | 585,90  | -     | -  | 11,60     |
| 560  | 450  | RCP560450A   | 585,90  | 18    | 1  | 10,40     |
| 560  | 500  | RCP560500A   | 585,90  | -     | -  | 11,00     |
| 630  | 450  | RCP630450A   | 747,60  | -     | -  | 10,60     |
| 630  | 500  | RCP630500A   | 747,60  | 12    | 1  | 11,42     |
| 630  | 560  | RCP630560A   | 747,60  | 12    | 1  | 9,90      |
| 710  | 560  | RCP710560A   | 1027,20 | 10    | 1  | 13,80     |
| 710  | 630  | RCP710630A   | 1027,20 | 10    | 1  | 12,10     |
| 800  | 710  | RCP800710A   | 1287,30 | 7     | 1  | 14,30     |
| 900  | 800  | RCP900800A   | 1560,70 | -     | -  | 18,60     |
| 1000 | 900  | RCP1000900A  | 2731,40 | -     | -  | 22,00     |
| 1200 | 1000 | RCP12001000A | 7153,30 | -     | -  | 32,70     |



## Riduzione codolo corto

Fabbricato mediante stampaggio

Utilizzo solo mediante saldatura ad elementi termici per contatto (testa a testa)

### SDR17 PN10

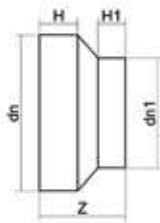

| dn   | dn1  | codice       | €       | Q Box | CP | Peso [kg] |
|------|------|--------------|---------|-------|----|-----------|
| 250  | 160  | RCP250160B   | 76,70   | 6     | 16 | 1,80      |
| 250  | 180  | RCP250180B   | 76,70   | 6     | 16 | 1,90      |
| 250  | 200  | RCP250200B   | 76,70   | -     | -  | 2,00      |
| 250  | 225  | RCP250225B   | 76,70   | -     | -  | 2,60      |
| 280  | 200  | RCP280200B   | 89,50   | 125   | 1  | 3,00      |
| 280  | 225  | RCP280225B   | 89,50   | 110   | 1  | 2,60      |
| 280  | 250  | RCP280250B   | 89,50   | 84    | 1  | 2,80      |
| 315  | 225  | RCP315225B   | 94,50   | 72    | 1  | 3,40      |
| 315  | 250  | RCP315250B   | 94,50   | 72    | 1  | 3,40      |
| 315  | 280  | RCP315280B   | 94,50   | 54    | 1  | 3,80      |
| 355  | 225  | RCP355225B   | 114,90  | 54    | 1  | 5,00      |
| 355  | 250  | RCP355250B   | 114,90  | 54    | 1  | 5,00      |
| 355  | 280  | RCP355280B   | 114,90  | 48    | 1  | 5,40      |
| 355  | 315  | RCP355315B   | 114,90  | 36    | 1  | 5,60      |
| 400  | 280  | RCP400280B   | 210,60  | 48    | 1  | 5,60      |
| 400  | 315  | RCP400315B   | 210,60  | 48    | 1  | 6,20      |
| 400  | 355  | RCP400355B   | 210,60  | 30    | 1  | 7,20      |
| 450  | 315  | RCP450315B   | 333,10  | 24    | 1  | 8,00      |
| 450  | 355  | RCP450355B   | 333,10  | 20    | 1  | 8,40      |
| 450  | 400  | RCP450400B   | 333,10  | 20    | 1  | 9,00      |
| 500  | 355  | RCP500355B   | 522,70  | 15    | 1  | 11,00     |
| 500  | 400  | RCP500400B   | 522,70  | 18    | 1  | 10,80     |
| 500  | 450  | RCP500450B   | 522,70  | 18    | 1  | 10,00     |
| 560  | 400  | RCP560400B   | 599,90  | 16    | 1  | 13,00     |
| 560  | 450  | RCP560450B   | 599,90  | 18    | 1  | 11,20     |
| 560  | 500  | RCP560500B   | 599,90  | 18    | 1  | 12,00     |
| 630  | 450  | RCP630450B   | 791,40  | 10    | 1  | 13,80     |
| 630  | 500  | RCP630500B   | 791,40  | 12    | 1  | 13,40     |
| 630  | 560  | RCP630560B   | 791,40  | 12    | 1  | 12,00     |
| 710  | 560  | RCP710560B   | 1135,90 | 10    | 1  | 15,05     |
| 710  | 630  | RCP710630B   | 1135,90 | 10    | 1  | 14,60     |
| 800  | 710  | RCP800710B   | 1531,60 | 7     | 1  | 18,80     |
| 900  | 800  | RCP900800B   | 2169,70 | 8     | 1  | 27,77     |
| 1000 | 900  | RCP1000900B  | 3701,40 | -     | -  | 29,60     |
| 1200 | 1000 | RCP12001000B | 8934,00 | -     | -  | 45,00     |



## Riduzione codolo corto

Fabbricato mediante stampaggio

Utilizzo solo mediante saldatura ad elementi termici per contatto (testa a testa)

### SDR11 PN16

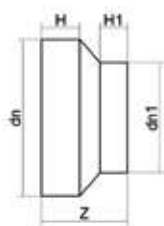

| dn   | dn1 | codice      | €       | Q Box | CP | Peso [kg] |
|------|-----|-------------|---------|-------|----|-----------|
| 250  | 160 | RCP250160C  | 89,50   | 6     | 16 | 2,40      |
| 250  | 180 | RCP250180C  | 89,50   | -     | -  | 2,60      |
| 250  | 200 | RCP250200C  | 89,50   | -     | -  | 2,70      |
| 250  | 225 | RCP250225C  | 89,50   | -     | -  | 2,90      |
| 280  | 200 | RCP280200C  | 107,20  | 114   | 1  | 3,20      |
| 280  | 225 | RCP280225C  | 107,20  | 110   | 1  | 3,50      |
| 280  | 250 | RCP280250C  | 107,20  | 84    | 1  | 3,60      |
| 315  | 225 | RCP315225C  | 113,60  | 72    | 1  | 5,00      |
| 315  | 250 | RCP315250C  | 113,60  | 72    | 1  | 5,00      |
| 315  | 280 | RCP315280C  | 113,60  | 54    | 1  | 5,34      |
| 355  | 225 | RCP355225C  | 139,00  | 48    | 1  | 6,28      |
| 355  | 250 | RCP355250C  | 139,00  | 48    | 1  | 6,28      |
| 355  | 280 | RCP355280C  | 139,00  | 48    | 1  | 7,20      |
| 355  | 315 | RCP355315C  | 139,00  | 35    | 1  | 7,40      |
| 400  | 280 | RCP400280C  | 265,40  | 42    | 1  | 9,00      |
| 400  | 315 | RCP400315C  | 265,40  | 42    | 1  | 9,80      |
| 400  | 355 | RCP400355C  | 265,40  | 30    | 1  | 11,80     |
| 450  | 315 | RCP450315C  | 421,20  | 28    | 1  | 10,80     |
| 450  | 355 | RCP450355C  | 421,20  | 20    | 1  | 11,80     |
| 450  | 400 | RCP450400C  | 421,20  | 20    | 1  | 11,90     |
| 500  | 355 | RCP500355C  | 622,80  | 15    | 1  | 14,00     |
| 500  | 400 | RCP500400C  | 622,80  | 18    | 1  | 14,80     |
| 500  | 450 | RCP500450C  | 622,80  | 18    | 1  | 13,00     |
| 560  | 400 | RCP560400C  | 804,70  | 16    | 1  | 18,20     |
| 560  | 450 | RCP560450C  | 804,70  | 18    | 1  | 16,60     |
| 560  | 500 | RCP560500C  | 804,70  | 16    | 1  | 17,00     |
| 630  | 450 | RCP630450C  | 995,60  | 10    | 1  | 19,20     |
| 630  | 500 | RCP630500C  | 995,60  | 12    | 1  | 18,40     |
| 630  | 560 | RCP630560C  | 995,60  | 12    | 1  | 17,40     |
| 710  | 560 | RCP710560C  | 1646,40 | 10    | 1  | 21,20     |
| 710  | 630 | RCP710630C  | 1646,40 | 10    | 1  | 21,00     |
| 800  | 710 | RCP800710C  | 1823,30 | 7     | 1  | 26,60     |
| 900  | 800 | RCP900800C  | 2431,10 | -     | -  | 33,60     |
| 1000 | 900 | RCP1000900C | 3768,10 | -     | -  | 42,80     |

Stampati



## Riduzione codolo corto

Fabbricato mediante stampaggio

Utilizzo solo mediante saldatura ad elementi termici per contatto (testa a testa)

### SDR9 PN20

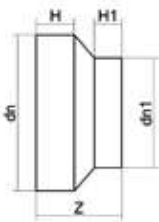

| dn  | dn1 | codice     | €       | Q Box | CP | Peso [kg] |
|-----|-----|------------|---------|-------|----|-----------|
| 250 | 160 | RCP250160G | 172,60  | 6     | 16 | 2,80      |
| 250 | 180 | RCP250180G | 172,60  | 6     | 16 | 2,90      |
| 250 | 200 | RCP250200G | 172,60  | -     | -  | 3,00      |
| 250 | 225 | RCP250225G | 172,60  | -     | -  | 3,10      |
| 280 | 200 | RCP280200G | 204,20  | -     | -  | 3,40      |
| 280 | 225 | RCP280225G | 204,20  | 110   | 1  | 3,80      |
| 280 | 250 | RCP280250G | 204,20  | -     | -  | 4,00      |
| 315 | 225 | RCP315225G | 223,70  | 72    | 1  | 6,20      |
| 315 | 250 | RCP315250G | 223,70  | 72    | 1  | 5,66      |
| 315 | 280 | RCP315280G | 223,70  | 54    | 1  | 6,20      |
| 355 | 250 | RCP355250G | 331,90  | -     | -  | 8,00      |
| 355 | 280 | RCP355280G | 331,90  | -     | -  | 8,50      |
| 355 | 315 | RCP355315G | 331,90  | -     | -  | 9,00      |
| 400 | 280 | RCP400280G | 663,70  | -     | -  | 12,00     |
| 400 | 315 | RCP400315G | 663,70  | 24    | 1  | 11,50     |
| 400 | 355 | RCP400355G | 663,70  | 30    | 1  | 12,10     |
| 450 | 315 | RCP450315G | 692,80  | 20    | 1  | 12,00     |
| 450 | 355 | RCP450355G | 692,80  | -     | -  | 14,00     |
| 450 | 400 | RCP450400G | 692,80  | 20    | 1  | 14,60     |
| 500 | 355 | RCP500355G | 850,90  | 15    | 1  | 16,80     |
| 500 | 450 | RCP500450G | 850,90  | 18    | 1  | 15,20     |
| 560 | 400 | RCP560400G | 1203,40 | -     | -  | 17,32     |
| 560 | 450 | RCP560450G | 1203,40 | -     | -  | 15,80     |
| 630 | 500 | RCP630500G | 1337,10 | 12    | 1  | 18,65     |

### SDR7,4 PN25

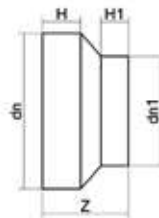

| dn  | dn1 | codice     | €      | Q Box | CP | Peso [kg] |
|-----|-----|------------|--------|-------|----|-----------|
| 250 | 160 | RCP250160H | 180,50 | 6     | 16 | 3,60      |
| 250 | 180 | RCP250180H | 180,50 | 6     | 16 | 3,70      |
| 250 | 200 | RCP250200H | 180,50 | -     | -  | 3,80      |
| 250 | 225 | RCP250225H | 180,50 | -     | -  | 3,90      |
| 280 | 200 | RCP280200H | 213,90 | 114   | 1  | 4,15      |
| 280 | 225 | RCP280225H | 213,90 | 110   | 1  | 4,60      |
| 280 | 250 | RCP280250H | 213,90 | 84    | 1  | 4,80      |
| 315 | 225 | RCP315225H | 233,90 | 72    | 1  | 6,50      |
| 315 | 250 | RCP315250H | 233,90 | 72    | 1  | 6,78      |
| 315 | 280 | RCP315280H | 233,90 | 54    | 1  | 7,10      |
| 355 | 250 | RCP355250H | 347,70 | 43    | 1  | 8,60      |
| 355 | 280 | RCP355280H | 347,70 | -     | -  | 9,10      |
| 355 | 315 | RCP355315H | 347,70 | 35    | 1  | 10,00     |

Continua

Altre misure e/o SDR a richiesta  
€...: Prezzo a richiesta





## Riduzione codolo corto

Fabbricato mediante stampaggio

Utilizzo solo mediante saldatura ad elementi termici per contatto (testa a testa)

### SDR7,4 PN25

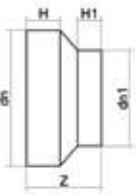

| dn  | dn1 | codice     | €       | Q Box | CP | Peso [kg] |
|-----|-----|------------|---------|-------|----|-----------|
| 400 | 280 | RCP400280H | 695,20  | 42    | 1  | 12,60     |
| 400 | 315 | RCP400315H | 695,20  | 24    | 1  | 12,22     |
| 400 | 355 | RCP400355H | 695,20  | 30    | 1  | 13,64     |
| 450 | 315 | RCP450315H | 790,00  | 20    | 1  | -         |
| 450 | 355 | RCP450355H | 790,00  | 20    | 1  | 15,40     |
| 450 | 400 | RCP450400H | 790,00  | 20    | 1  | 16,10     |
| 500 | 450 | RCP500450H | 899,50  | 18    | 1  | 18,70     |
| 560 | 400 | RCP560400H | 1337,10 | -     | -  | 19,90     |
| 560 | 450 | RCP560450H | 1337,10 | 18    | 1  | 17,70     |



## Adattatori per flange (cartella) codolo lungo

Fabbricato mediante stampaggio

L'assieme adattatore per flangia e flangia è certificato conforme a ISO 9624

Per flange forate PN10

### SDR17 PN10

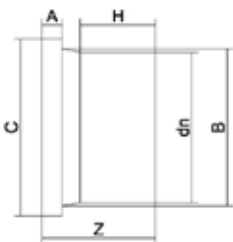

| dn   | codice | €      | Q Box | CP | Peso [kg] |
|------|--------|--------|-------|----|-----------|
| 63   | CP063B | 7,00   | 60    | 16 | 0,20      |
| 75   | CP075B | 8,90   | 40    | 16 | 0,30      |
| 90   | CP090B | 11,70  | 30    | 16 | 0,36      |
| *110 | CP110B | 15,30  | 24    | 12 | 0,57      |
| *125 | CP125B | 17,00  | 20    | 12 | 0,60      |
| *140 | CP140B | 22,40  | 12    | 12 | 1,10      |
| *160 | CP160B | 26,80  | 12    | 12 | 1,10      |
| *180 | CP180B | 43,80  | 144   | 1  | 1,50      |
| *200 | CP200B | 52,20  | 90    | 1  | 2,30      |
| *225 | CP225B | 55,90  | 84    | 1  | 2,70      |
| *250 | CP250B | 85,30  | 50    | 1  | 4,00      |
| *280 | CP280B | 124,00 | 45    | 1  | 4,10      |
| *315 | CP315B | 139,80 | 30    | 1  | 5,70      |
| *355 | CP355B | 239,50 | 24    | 1  | 7,80      |
| *400 | CP400B | 488,70 | 12    | 1  | 10,80     |

\* Idoneo per connessioni flangiate ASME B 16.5



## Adattatori per flange (cartella) codolo lungo

Fabbricato mediante stampaggio

L'assieme adattatore per flangia e flangia è certificato conforme a ISO 9624

Per flange forate PN16

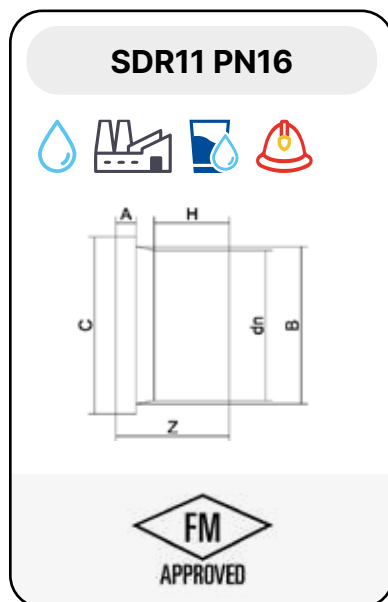

| dn   | codice | €      | Q Box | CP | Peso [kg] |
|------|--------|--------|-------|----|-----------|
| 20   | CP020C | 6,20   | 80    | 60 | 0,03      |
| 25   | CP025C | 6,20   | 70    | 60 | 0,04      |
| 32   | CP032C | 6,20   | 50    | 60 | 0,06      |
| 40   | CP040C | 6,70   | 30    | 60 | 0,08      |
| 50   | CP050C | 7,20   | 100   | 16 | 0,15      |
| 63   | CP063C | 7,90   | 60    | 16 | 0,20      |
| 75   | CP075C | 9,70   | 40    | 16 | 0,33      |
| 90   | CP090C | 12,80  | 30    | 16 | 0,40      |
| *110 | CP110C | 17,60  | 24    | 12 | 0,68      |
| *125 | CP125C | 18,30  | 20    | 12 | 0,90      |
| *140 | CP140C | 23,20  | 12    | 12 | 1,27      |
| *160 | CP160C | 29,80  | 12    | 12 | 1,65      |
| *180 | CP180C | 47,60  | 144   | 1  | 2,00      |
| *200 | CP200C | 55,30  | 75    | 1  | 3,90      |
| *225 | CP225C | 59,60  | 70    | 1  | 4,20      |
| *250 | CP250C | 91,10  | 50    | 1  | 6,10      |
| *280 | CP280C | 133,80 | 40    | 1  | 6,20      |
| *315 | CP315C | 156,90 | 24    | 1  | 8,10      |
| *355 | CP355C | 297,90 | 24    | 1  | 10,50     |
| *400 | CP400C | 528,80 | 12    | 1  | 17,30     |

\* Idoneo per connessioni flangiate ASME B 16.5



## Adattatori per flange (cartella) codolo lungo

Fabbricato mediante stampaggio

L'assieme adattatore per flangia e flangia è certificato conforme a ISO 9624

Per flange forate PN25

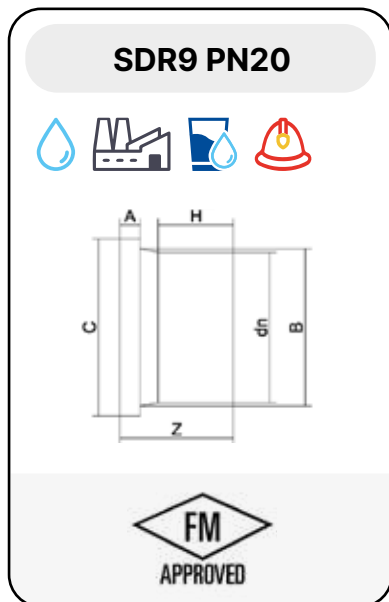

| dn   | codice | €      | Q Box | CP | Peso [kg] |
|------|--------|--------|-------|----|-----------|
| 63   | CP063G | 15,80  | 60    | 16 | 0,26      |
| 75   | CP075G | 18,40  | 40    | 16 | 0,30      |
| 90   | CP090G | 24,40  | 30    | 16 | 0,54      |
| *110 | CP110G | 31,50  | 24    | 12 | 0,90      |
| *125 | CP125G | 38,40  | 20    | 12 | 1,10      |
| *140 | CP140G | 47,70  | 12    | 12 | 1,60      |
| *160 | CP160G | 56,60  | 12    | 12 | 2,05      |
| *180 | CP180G | 82,40  | 144   | 1  | 2,07      |
| *200 | CP200G | 108,00 | 75    | 1  | 4,00      |
| *225 | CP225G | 145,80 | 72    | 1  | 4,10      |
| *250 | CP250G | 182,40 | 50    | 1  | 6,70      |
| *280 | CP280G | 255,30 | 40    | 1  | 7,20      |
| *315 | CP315G | 340,30 | 24    | 1  | 9,20      |
| *400 | CP400G | 753,70 | 12    | 1  | 21,10     |

\* Idoneo per connessioni flangiate ASME B 16.5



## Adattatori per flange (cartella) codolo lungo

Fabbricato mediante stampaggio

L'assieme adattatore per flangia e flangia è certificato conforme a ISO 9624

Per flange forate PN25

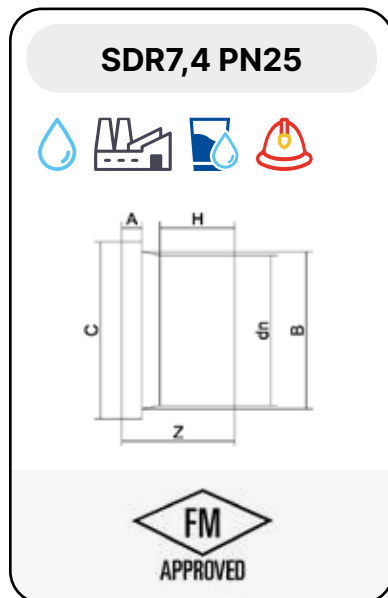

| dn   | codice | €      | Q Box | CP | Peso [kg] |
|------|--------|--------|-------|----|-----------|
| 25   | CP025H | 12,30  | 70    | 60 | 0,04      |
| 32   | CP032H | 12,80  | 50    | 60 | 0,06      |
| 40   | CP040H | 13,70  | 30    | 60 | 0,10      |
| 50   | CP050H | 14,20  | 100   | 16 | 0,16      |
| 63   | CP063H | 15,10  | 60    | 16 | 0,28      |
| 75   | CP075H | 17,60  | 40    | 16 | 0,43      |
| 90   | CP090H | 23,30  | 30    | 16 | 0,63      |
| *110 | CP110H | 30,00  | 24    | 12 | 0,91      |
| *125 | CP125H | 36,80  | 20    | 12 | 1,18      |
| *140 | CP140H | 45,60  | 12    | 12 | 1,88      |
| *160 | CP160H | 54,10  | 12    | 12 | 2,10      |
| *180 | CP180H | 78,90  | 144   | 1  | 2,70      |
| *200 | CP200H | 103,40 | 75    | 1  | 5,00      |
| *225 | CP225H | 160,40 | 70    | 1  | 5,20      |
| *250 | CP250H | 200,70 | 50    | 1  | 7,00      |
| *280 | CP280H | 280,80 | 40    | 1  | 7,90      |
| *315 | CP315H | 374,40 | 24    | 1  | 12,10     |

\* Idoneo per connessioni flangiate ASME B 16.5



## Adattatori per flange (cartella) codolo corto

Fabbricato mediante stampaggio

L'assieme adattatore per flangia e flangia è certificato conforme a ISO 9624

Per flange forate PN6

Utilizzo solo mediante saldatura ad elementi termici per contatto (testa a testa)

### SDR26 PN6

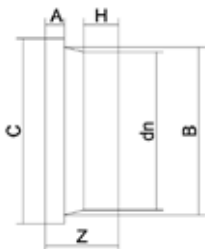

| dn   | codice   | €       | Q Box | CP | Peso [kg] |
|------|----------|---------|-------|----|-----------|
| 160  | CCP160A  | 22,60   | 24    | 12 | 0,50      |
| 180  | CCP180A  | 37,50   | -     | -  | 0,65      |
| 200  | CCP200A  | 46,10   | 8     | 12 | 2,00      |
| 225  | CCP225A  | 49,50   | 140   | 1  | 1,40      |
| 250  | CCP250A  | 64,30   | 6     | 12 | 2,20      |
| 280  | CCP280A  | 67,70   | 80    | 1  | 3,00      |
| 315  | CCP315A  | 81,10   | 54    | 1  | 4,40      |
| 355  | CCP355A  | 103,40  | 48    | 1  | 6,00      |
| 400  | CCP400A  | 194,50  | 30    | 1  | 6,70      |
| 450  | CCP450A  | 275,90  | 18    | 1  | 7,60      |
| 500  | CCP500A  | 291,70  | 20    | 1  | 8,10      |
| 560  | CCP560A  | 376,80  | 13    | 1  | 10,60     |
| 630  | CCP630A  | 395,10  | 13    | 1  | 8,60      |
| 710  | CCP710A  | 583,50  | 10    | 1  | 11,60     |
| 800  | CCP800A  | 848,40  | 8     | 1  | 14,80     |
| 900  | CCP900A  | 1045,40 | 7     | 1  | 19,40     |
| 1000 | CCP1000A | 1276,30 | 7     | 1  | 22,93     |
| 1200 | CCP1200A | 2139,30 | -     | -  | 39,10     |



## Adattatori per flange (cartella) codolo corto

Fabbricato mediante stampaggio

L'assieme adattatore per flangia e flangia è certificato conforme a ISO 9624

Per flange forate PN10

Utilizzo solo mediante saldatura ad elementi termici per contatto (testa a testa)

### SDR17 PN10

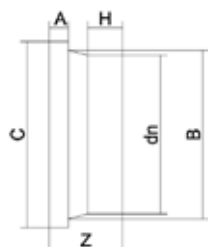

| dn   | codice   | €       | Q Box | CP | Peso [kg] |
|------|----------|---------|-------|----|-----------|
| 63   | CCP063B  | 6,90    | 100   | 16 | 0,13      |
| 75   | CCP075B  | 8,30    | 50    | 16 | 0,22      |
| 90   | CCP090B  | 11,30   | 45    | 16 | 0,26      |
| *110 | CCP110B  | 13,20   | 30    | 16 | 0,36      |
| *125 | CCP125B  | 15,50   | 28    | 16 | 0,41      |
| *140 | CCP140B  | 20,00   | 24    | 12 | 0,53      |
| *160 | CCP160B  | 23,60   | 24    | 12 | 0,65      |
| *180 | CCP180B  | 39,30   | 10    | 16 | 0,81      |
| *200 | CCP200B  | 48,20   | 8     | 12 | 2,20      |
| *225 | CCP225B  | 51,70   | 8     | 12 | 1,70      |
| *250 | CCP250B  | 67,10   | 6     | 12 | 2,60      |
| *280 | CCP280B  | 76,70   | 80    | 1  | 3,20      |
| *315 | CCP315B  | 91,10   | 54    | 1  | 4,60      |
| *355 | CCP355B  | 137,30  | 48    | 1  | 6,30      |
| *400 | CCP400B  | 228,60  | 30    | 1  | 7,10      |
| *450 | CCP450B  | 361,10  | 18    | 1  | 10,90     |
| *500 | CCP500B  | 374,40  | 20    | 1  | 9,20      |
| *560 | CCP560B  | 521,50  | 13    | 1  | 14,00     |
| *630 | CCP630B  | 595,00  | 13    | 1  | 12,80     |
| 710  | CCP710B  | 775,50  | 10    | 1  | 17,80     |
| 800  | CCP800B  | 1083,10 | 8     | 1  | 22,40     |
| 900  | CCP900B  | 1470,70 | 7     | 1  | 29,40     |
| 1000 | CCP1000B | 2259,70 | 7     | 1  | 37,80     |
| 1200 | CCP1200B | 4679,60 | -     | -  | 68,80     |

\* Idoneo per connessioni flangiate ASME B 16.5



## Adattatori per flange (cartella) codolo corto

Fabbricato mediante stampaggio

L'assieme adattatore per flangia e flangia è certificato conforme a ISO 9624

Per flange forate PN16

Utilizzo solo mediante saldatura ad elementi termici per contatto (testa a testa)

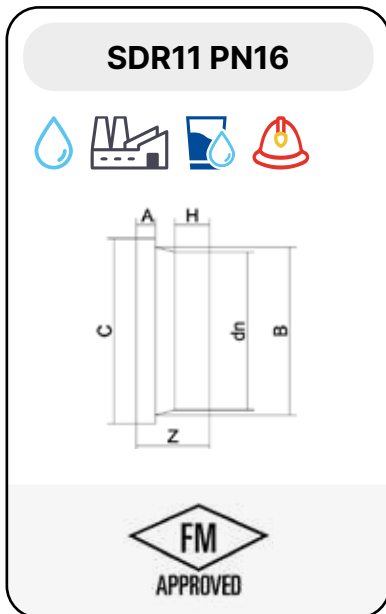

| dn   | codice   | €       | Q Box | CP | Peso [kg] |
|------|----------|---------|-------|----|-----------|
| 63   | CCP063C  | 7,20    | 100   | 16 | 0,16      |
| 75   | CCP075C  | 8,60    | 50    | 16 | 0,23      |
| 90   | CCP090C  | 12,00   | 45    | 16 | 0,31      |
| *110 | CCP110C  | 14,40   | 40    | 12 | 0,44      |
| *125 | CCP125C  | 16,90   | 28    | 16 | 0,50      |
| *140 | CCP140C  | 21,80   | 24    | 12 | 0,77      |
| *160 | CCP160C  | 25,60   | 24    | 12 | 0,97      |
| *180 | CCP180C  | 42,50   | 10    | 16 | 1,15      |
| *200 | CCP200C  | 52,60   | 7     | 12 | 2,80      |
| *225 | CCP225C  | 56,30   | 8     | 12 | 2,70      |
| *250 | CCP250C  | 72,70   | 6     | 12 | 4,20      |
| *280 | CCP280C  | 88,20   | 74    | 1  | 4,26      |
| *315 | CCP315C  | 115,20  | 48    | 1  | 6,20      |
| *355 | CCP355C  | 157,50  | 48    | 1  | 8,30      |
| *400 | CCP400C  | 299,00  | 28    | 1  | 9,50      |
| 450  | CCP450C  | 474,10  | 18    | 1  | 17,00     |
| *500 | CCP500C  | 481,30  | 18    | 1  | 16,10     |
| *560 | CCP560C  | 615,10  | 11    | 1  | 21,20     |
| *630 | CCP630C  | 695,20  | 10    | 1  | 20,40     |
| 710  | CCP710C  | 1283,50 | 9     | 1  | 28,40     |
| 800  | CCP800C  | 2005,60 | 8     | 1  | 37,20     |
| 900  | CCP900C  | 2917,20 | 7     | 1  | 49,20     |
| 1000 | CCP1000C | 3768,10 | -     | -  | 62,20     |
| 1200 | CCP1200C | 6685,40 | -     | -  | 106,00    |

\* Idoneo per connessioni flangiate ASME B 16.5



## Adattatori per flange (cartella) codolo corto

Fabbricato mediante stampaggio

L'assieme adattatore per flangia e flangia è certificato conforme a ISO 9624

Per flange forate PN25

Utilizzo solo mediante saldatura ad elementi termici per contatto (testa a testa)

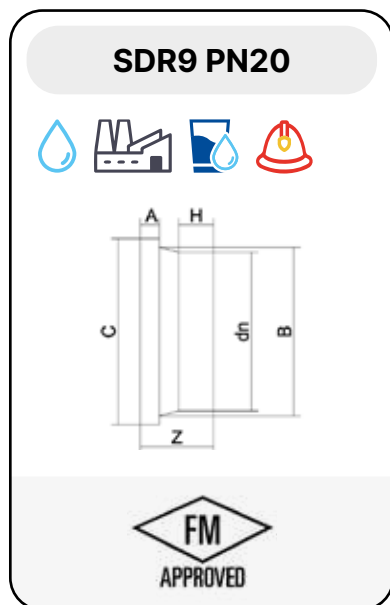

| dn   | codice  | €        | Q Box | CP | Peso [kg] |
|------|---------|----------|-------|----|-----------|
| *280 | CCP280G | 200,70   | 74    | 1  | 4,20      |
| *315 | CCP315G | 223,70   | 48    | 1  | 8,80      |
| 355  | CCP355G | 285,70   | 40    | 1  | 9,60      |
| *400 | CCP400G | 539,70   | 28    | 1  | 14,80     |
| 450  | CCP450G | 850,90   | 18    | 1  | 17,60     |
| 500  | CCP500G | 923,80   | 18    | 1  | 18,20     |
| 560  | CCP560G | 1.450,00 | 18    | 1  | 26,20     |
| 630  | CCP630G | €...     | 12    | 1  | 26,80     |

\* Idoneo per connessioni flangiate ASME B 16.5

Per flange forate PN25

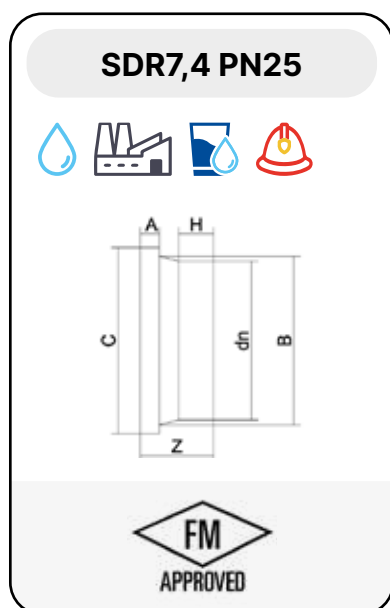

| dn   | codice  | €        | Q Box | CP | Peso [kg] |
|------|---------|----------|-------|----|-----------|
| *280 | CCP280H | 212,80   | 74    | 1  | 5,00      |
| *315 | CCP315H | 237,10   | 48    | 1  | 9,20      |
| 355  | CCP355H | 303,90   | 40    | 1  | 10,70     |
| *400 | CCP400H | 593,10   | 28    | 1  | 16,20     |
| 450  | CCP450H | 935,90   | 18    | 1  | 19,80     |
| 500  | CCP500H | 1016,20  | 18    | 1  | 20,40     |
| 560  | CCP560H | 1.600,00 | 11    | 1  | 34,00     |
| 630  | CCP630H | €...     | -     | -  | -         |

\* Idoneo per connessioni flangiate ASME B 16.5

Altre misure e/o SDR a richiesta  
€...: Prezzo a richiesta





## Adattatori per flange (cartella) codolo lungo per valvola a farfalla (wafer - lug)

Fabbricato mediante stampaggio e lavorazione meccanica

L'assieme adattatore per flangia e flangia è certificato conforme a ISO 9624

Per flange forate PN10

### SDR17 PN10

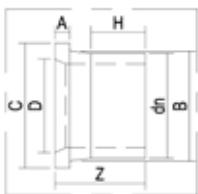

| dn           | codice    | €      | Q Box | CP | Peso [kg] | max Ø disco valve (mm) |
|--------------|-----------|--------|-------|----|-----------|------------------------|
| 140          | CP140B.SV | 27,60  | -     | -  | 1,00      | 126,0                  |
| <b>N</b> 160 | CP160B.SV | 34,50  | -     | -  | 1,10      | 153,0                  |
| 200          | CP200B.SV | 63,60  | 90    | 1  | 2,20      | 202,0                  |
| 250          | CP250B.SV | 105,00 | 50    | 1  | 3,40      | 252,0                  |
| <b>N</b> 280 | CP280B.SV | 154,00 | -     | -  | 3,50      | 254,0                  |
| 315          | CP315B.SV | 181,00 | 30    | 1  | 5,10      | 303,0                  |

- Nota: per i diametri non indicati utilizzare i prodotti dei codici CPxxxB (con esclusione dei codici CP355B e CP400B);

Nota: Per la completa apertura delle valvole la distanza tra le flange (Face-to-Face – FTF) deve essere secondo UNI EN 558-1 serie 20 (vedere schede tecniche valvole a farfalla).

Per flange forate PN16

### SDR11 PN16

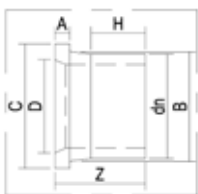

| dn          | codice    | €      | Q Box | CP | Peso [kg] | max Ø disco valve (mm) |
|-------------|-----------|--------|-------|----|-----------|------------------------|
| <b>N</b> 90 | CP090C.SV | 15,90  | -     | -  | 0,40      | 78,0                   |
| 110         | CP110C.SV | 20,70  | 24    | 12 | 0,65      | 98,0                   |
| 140         | CP140C.SV | 28,00  | 12    | 12 | 1,24      | 1,18                   |
| 160         | CP160C.SV | 34,30  | 12    | 12 | 1,55      | 153,0                  |
| 180         | CP180C.SV | 54,80  | 144   | 1  | 1,80      | 155,0                  |
| 200         | CP200C.SV | 119,00 | 75    | 1  | 3,50      | 204,0                  |
| 225         | CP225C.SV | 119,00 | 70    | 1  | 4,05      | 202,0                  |
| 250         | CP250C.SV | 231,00 | 50    | 1  | 4,50      | 250,0                  |
| 280         | CP280C.SV | 280,00 | 40    | 1  | 5,50      | 254,0                  |
| 315         | CP315C.SV | 431,00 | 24    | 1  | 7,50      | 303,0                  |

- Nota: per i diametri non indicati utilizzare i prodotti dei codici CPxxxC;

Nota: Per la completa apertura delle valvole la distanza tra le flange (Face-to-Face – FTF) deve essere secondo UNI EN 558-1 serie 20 (vedere schede tecniche valvole a farfalla).



## Fine linea (calotta) codolo lungo

Fabbricato mediante stampaggio

### SDR17 PN10

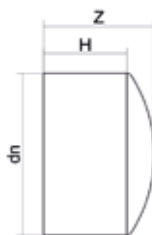

| dn           | codice   | €      | Q Box | CP | Peso [kg] |
|--------------|----------|--------|-------|----|-----------|
| 63           | CAP063B  | 9,20   | 76    | 32 | 0,08      |
| 75           | CAP075B  | 10,70  | 54    | 32 | 0,11      |
| 90           | CAP090B  | 13,10  | 32    | 32 | 0,18      |
| 110          | CAP110B  | 19,70  | 45    | 12 | 0,30      |
| 125          | CAP125B  | 22,20  | 30    | 16 | 0,36      |
| 140          | CAP140B  | 36,00  | 33    | 12 | 0,75      |
| 160          | CAP160B  | 36,90  | 14    | 16 | 0,87      |
| 180          | CAP180B  | 44,30  | 12    | 16 | 0,96      |
| 200          | CAP200B  | 72,20  | 7     | 16 | 1,50      |
| 225          | CAP225B  | 89,70  | 119   | 1  | 2,00      |
| 250          | CAP250B  | 97,50  | 6     | 16 | 2,20      |
| 280          | CAP280B  | 124,00 | 66    | 1  | 3,20      |
| 315          | CAP315B  | 221,20 | 40    | 1  | 5,00      |
| <b>N</b> 400 | CALP400B | 720,00 | 30    | 1  | -         |

### SDR11 PN16

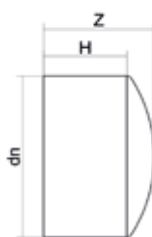

| dn           | codice   | €      | Q Box | CP | Peso [kg] |
|--------------|----------|--------|-------|----|-----------|
| 20           | CAP020C  | 4,70   | 250   | 60 | 0,01      |
| 25           | CAP025C  | 4,70   | 250   | 60 | 0,01      |
| 32           | CAP032C  | 6,30   | 150   | 60 | 0,02      |
| 40           | CAP040C  | 7,20   | 100   | 60 | 0,04      |
| 50           | CAP050C  | 8,70   | 130   | 32 | 0,06      |
| 63           | CAP063C  | 10,00  | 76    | 32 | 0,10      |
| 75           | CAP075C  | 11,60  | 54    | 32 | 0,16      |
| 90           | CAP090C  | 14,20  | 32    | 32 | 0,24      |
| 110          | CAP110C  | 21,40  | 45    | 12 | 0,45      |
| 125          | CAP125C  | 24,00  | 36    | 16 | 0,51      |
| 140          | CAP140C  | 39,10  | 33    | 12 | 0,90      |
| 160          | CAP160C  | 40,10  | 14    | 16 | 1,10      |
| 180          | CAP180C  | 48,20  | 12    | 16 | 1,42      |
| 200          | CAP200C  | 78,60  | 7     | 16 | 2,00      |
| 225          | CAP225C  | 97,50  | 119   | 1  | 2,80      |
| 250          | CAP250C  | 105,60 | 6     | 16 | 3,20      |
| 280          | CAP280C  | 135,00 | 66    | 1  | 4,36      |
| 315          | CAP315C  | 240,70 | 40    | 1  | 6,60      |
| <b>N</b> 400 | CALP400C | 860,00 | 30    | 1  | 14,00     |

Altre misure e/o SDR a richiesta  
 €...: Prezzo a richiesta



## Fine linea (calotta) codolo lungo

Fabbricato mediante stampaggio

### SDR9 PN20

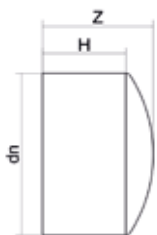

| dn  | codice  | €      | Q Box | CP | Peso [kg] |
|-----|---------|--------|-------|----|-----------|
| 63  | CAP063G | 18,30  | 76    | 32 | 0,13      |
| 75  | CAP075G | 26,80  | 48    | 32 | 0,19      |
| 90  | CAP090G | 43,40  | 32    | 32 | 0,29      |
| 110 | CAP110G | 57,90  | 45    | 12 | 0,57      |
| 125 | CAP125G | 62,30  | 36    | 16 | 0,96      |
| 140 | CAP140G | 92,60  | 33    | 12 | 0,90      |
| 160 | CAP160G | 98,60  | 14    | 16 | 1,50      |
| 180 | CAP180G | 130,10 | 12    | 16 | 1,82      |
| 200 | CAP200G | 144,80 | 6     | 16 | 2,70      |
| 225 | CAP225G | 175,00 | 6     | 16 | 3,30      |
| 250 | CAP250G | 194,50 | 6     | 16 | 4,00      |
| 280 | CAP280G | 295,50 | 66    | 1  | 5,80      |
| 315 | CAP315G | 407,30 | 3     | 12 | 8,60      |

### SDR7,4 PN25

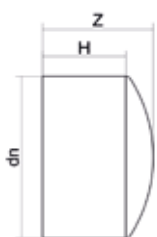

| dn  | codice  | €      | Q Box | CP | Peso [kg] |
|-----|---------|--------|-------|----|-----------|
| 25  | CAP025H | 8,00   | -     | -  | -         |
| 32  | CAP032H | 11,20  | 150   | 60 | -         |
| 40  | CAP040H | 13,10  | 80    | 60 | 0,05      |
| 50  | CAP050H | 15,10  | 130   | 32 | 0,08      |
| 63  | CAP063H | 19,30  | 76    | 32 | 0,15      |
| 75  | CAP075H | 28,40  | 48    | 32 | 0,21      |
| 90  | CAP090H | 45,90  | 32    | 32 | 0,33      |
| 110 | CAP110H | 61,40  | 45    | 12 | 0,60      |
| 125 | CAP125H | 66,00  | 36    | 16 | 1,00      |
| 140 | CAP140H | 98,20  | 33    | 12 | 0,96      |
| 160 | CAP160H | 104,40 | 14    | 16 | 1,58      |
| 180 | CAP180H | 137,30 | 12    | 16 | 1,80      |
| 200 | CAP200H | 153,10 | 6     | 16 | 2,80      |
| 225 | CAP225H | 184,80 | 6     | 16 | 3,40      |
| 250 | CAP250H | 205,50 | 6     | 16 | 4,15      |
| 280 | CAP280H | 312,50 | 66    | 1  | 6,00      |
| 315 | CAP315H | 431,60 | 3     | 12 | 8,80      |

Altre misure e/o SDR a richiesta  
€...: Prezzo a richiesta



## Fine linea (calotta) codolo corto

Fabbricato mediante stampaggio

Utilizzo solo mediante saldatura ad elementi termici per contatto (testa a testa)

### SDR17 PN10

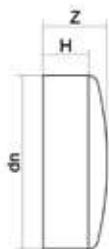

| dn  | codice  | €       | Q Box | CP | Peso [kg] |
|-----|---------|---------|-------|----|-----------|
| 355 | CAP355B | 279,60  | 40    | 1  | 4,60      |
| 400 | CAP400B | 425,50  | 42    | 1  | 7,36      |
| 450 | CAP450B | 546,90  | 24    | 1  | 9,20      |
| 500 | CAP500B | 717,20  | -     | -  | 12,60     |
| 560 | CAP560B | 911,60  | 18    | 1  | 15,90     |
| 630 | CAP630B | 1519,40 | 9     | 1  | 24,00     |
| 710 | CAP710B | €...    | -     | -  | -         |
| 800 | CAP800B | €...    | -     | -  | -         |

### SDR11 PN16

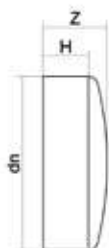

| dn  | codice  | €       | Q Box | CP | Peso [kg] |
|-----|---------|---------|-------|----|-----------|
| 355 | CAP355C | 382,90  | -     | -  | 7,80      |
| 400 | CAP400C | 559,20  | 48    | 1  | 9,30      |
| 450 | CAP450C | 802,30  | 10    | 1  | 11,40     |
| 500 | CAP500C | 911,60  | 28    | 1  | 15,20     |
| 560 | CAP560C | 1276,30 | 16    | 1  | 20,90     |
| 630 | CAP630C | 1762,40 | -     | -  | 31,40     |
| 710 | CAP710C | €...    | -     | -  | -         |
| 800 | CAP800C | €...    | -     | -  | -         |

Altre misure e/o SDR a richiesta  
 €...: Prezzo a richiesta



## Fine linea (calotta) codolo corto

Fabbricato mediante stampaggio

Utilizzo solo mediante saldatura ad elementi termici per contatto (testa a testa)

### SDR9 PN20

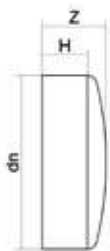

| dn  | codice  | €      | Q Box | CP | Peso [kg] |
|-----|---------|--------|-------|----|-----------|
| 355 | CAP355G | 765,50 | -     | -  | 8,20      |
| 400 | CAP400G | €...   | -     | -  | -         |
| 450 | CAP450G | €...   | -     | -  | -         |

### SDR7,4 PN25

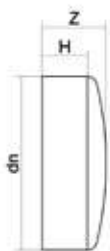

| dn  | codice  | €      | Q Box | CP | Peso [kg] |
|-----|---------|--------|-------|----|-----------|
| 355 | CAP355H | 812,50 | -     | -  | 8,50      |
| 400 | CAP400H | €...   | -     | -  | -         |
| 450 | CAP450H | €...   | -     | -  | -         |